



# DEM Jugend A 2017

am 05.02.2017

## J Am+78



### Draw Sheet

**153** Barcin , Birkan  
BTU , TSV 1865 Dachau

**B**

7

**224**

10

**32** Bach , Marcel  
BTU , Türk SV 1990 Bobingen

**R**

**32 /B**

20 **32** 18

**241**

**132 /R**

**B**

16

**225**

10

Johnson , Patrick **132**  
BTU , Moo Duk Kwan e.V. Bad Windsheim

**R**

Vögeli , Urs Benedict **114**  
TURP , Taekwondo Club Ingelheim e.V.

1. Marcel Bach (Türk SV 1990 Bobingen, BTU)
2. Patrick Johnson (Moo Duk Kwan e.V. Bad Windsheim, BTU)
3. Birkan Barcin (TSV 1865 Dachau, BTU)
3. Urs Benedict Vögeli (Taekwondo Club Ingelheim e.V., TURP)



# DEM Jugend A 2017

am 05.02.2017  
J Am-45



## Draw Sheet

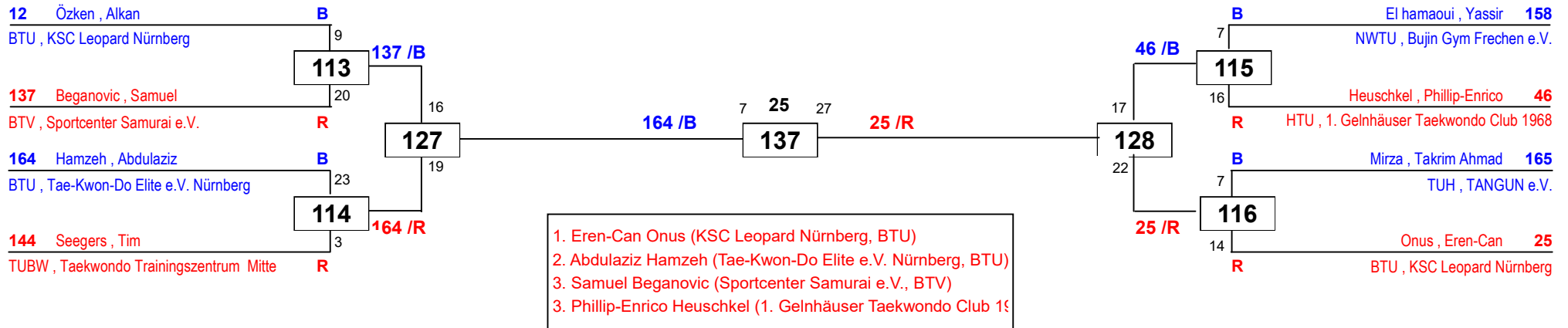



# DEM Jugend A 2017

am 05.02.2017  
J Am-48



## Draw Sheet

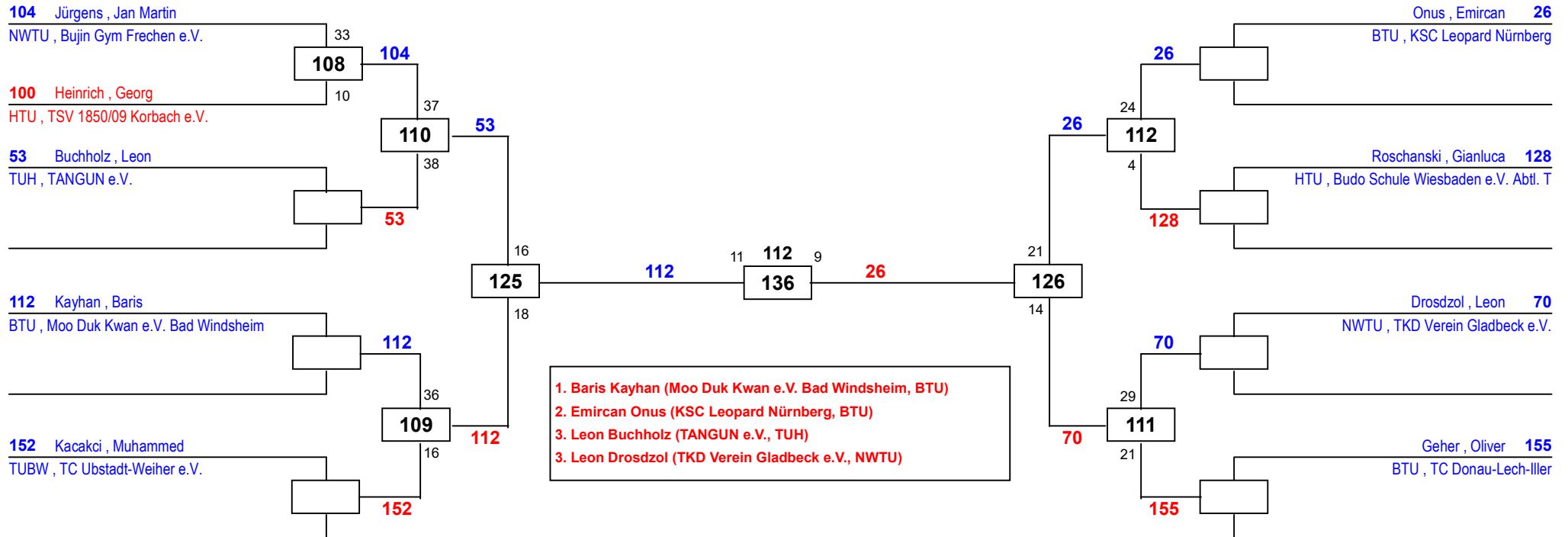



# DEM Jugend A 2017

am 05.02.2017

## J Am-51



### Draw Sheet

**187** Wolf, Jason, Alwin  
TUBW, TKD Ates e.V.

**151** Amonat, Marc Marvin  
NWTU, Königsborner Sportverein 1880/191

**86** Erdmann, Maik  
TVBB, Taekwondo Elite Berlin e.V.

**185** Aydin, Emre  
TUBW, TKD Center Stuttgart e.V.

**107** Khlifi, Mohamed  
NWTU, OTC Bonn e.V.

**11** Canan, Hüseyin-Alperen  
BTU, TC Donau-Lech-Iller

**148** Pelcz, Marvin  
TUBW, BSV. Friedrichshafen e.V.

**62** Bartl, Timon  
BTU, TSV Murnau 1865 e.V.

**68** Yavuz, Hamza  
NWTU, Sportwerk Düsseldorf e.V.

**52** Grimm, Michael  
BTU, Sport Academy e.V.

**191** Bayram, Hamza  
NWTU, OTC Bonn e.V.

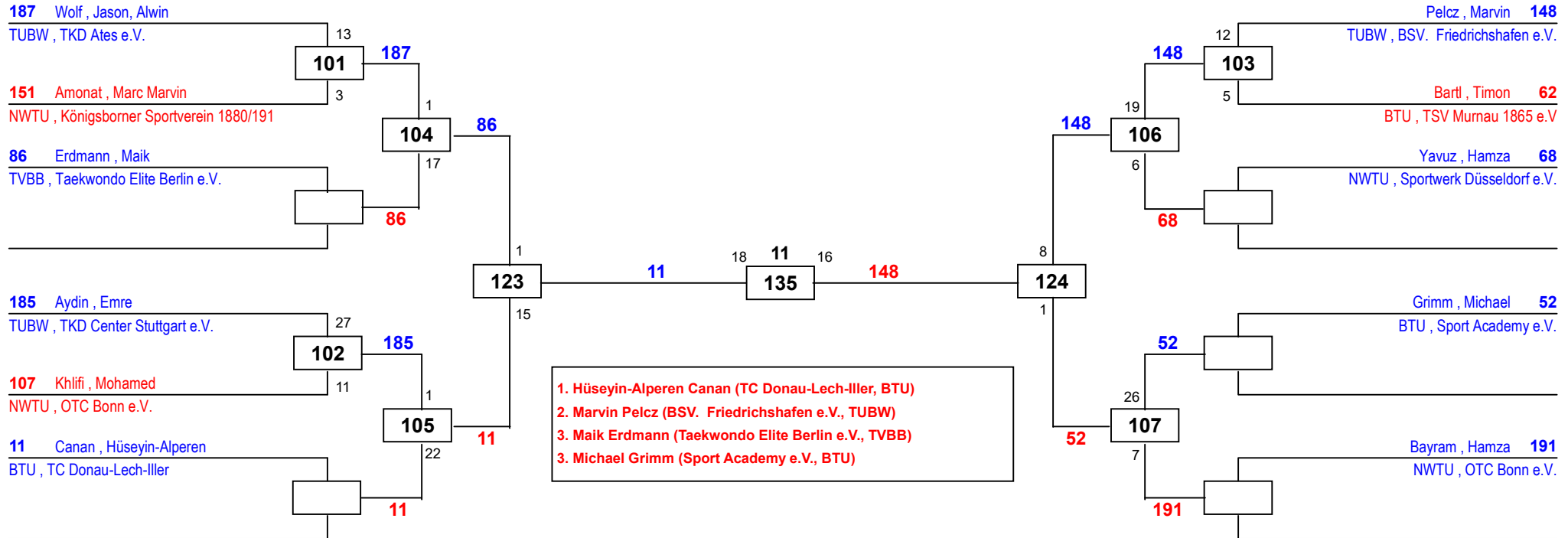

# J Am-55 DEM Jugend A 2017

Ingolstadt  
am 05.02.2017



Deutsche  
Taekwondo  
Union e.V.

Graf, Tobias 95

NWTU, Wuppertaler Tiger e.V.

Nitsas, Spiridon 175

BTU, TSV 1865 Dachau

Beganovic, Manuel 136

BTV, Sportcenter Samurai e.V.

Franzke, Marvin 40

NTU, BSV Jitae Stadthagen e.V. Abt. Tae

Radovic, Sasa 154

TUBW, TKD Verein Creti Tübingen e.V.

Malkoc, Cemal Can 57

TUH, TANGUN e.V.

Kiwitz, Benjamin 78

HTU, Taekwondo Schlüchtern e.V.

Andreopoulos, Antonios 157

NWTU, Sportwerk Düsseldorf e.V.

36 Karademir, Tolga  
BTU, KSC Leopard Nürnberg

92 Yousufi, Mohammad  
NWTU, Kangaroo Sports e.V.

33 Richter, Rico  
TUT, TuS Osterburg 90 Weida e.V. Abt. T

47 Butschek, Pascal  
TUSA, TKD Gemeinschaft Schönebeck e.V.

124 Mahler, Tom  
TUS, Taifun Leipzig e.V.

138 Schulz, Leon  
TUBW, TKD Ates e.V.

84 Bavosa, Timmy  
BTU, TKD Özer

141 Ilias, Karabila  
HTU, Han Dok Wiesbaden e.V.

81 Drebes, Ranye  
TVBB, Taekwondo Elite Berlin e.V.

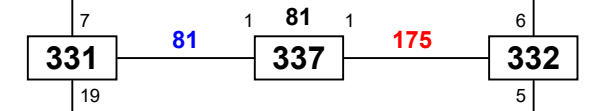
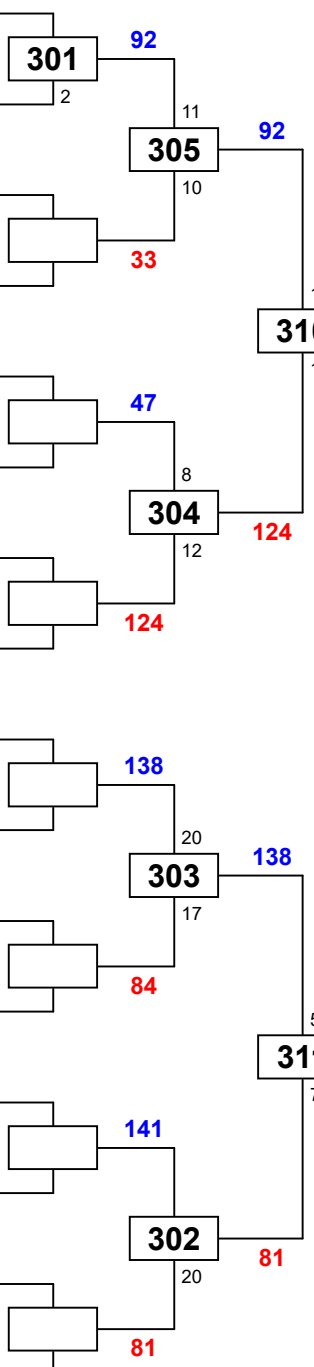

1. Ranye Drebes (Taekwondo Elite Berlin e.V., TVBB)
2. Spiridon Nitsas (TSV 1865 Dachau, BTU)
3. Antonios Andreopoulos (Sportwerk Düsseldorf e.V., NWTU)
3. Mohammad Yousufi (Kangaroo Sports e.V., NWTU)

Tournament Management by: DELTA SYSTEM HOUSE  
www.deltapool.de

Copyright by Hamid Rahimi 1994 - 2016

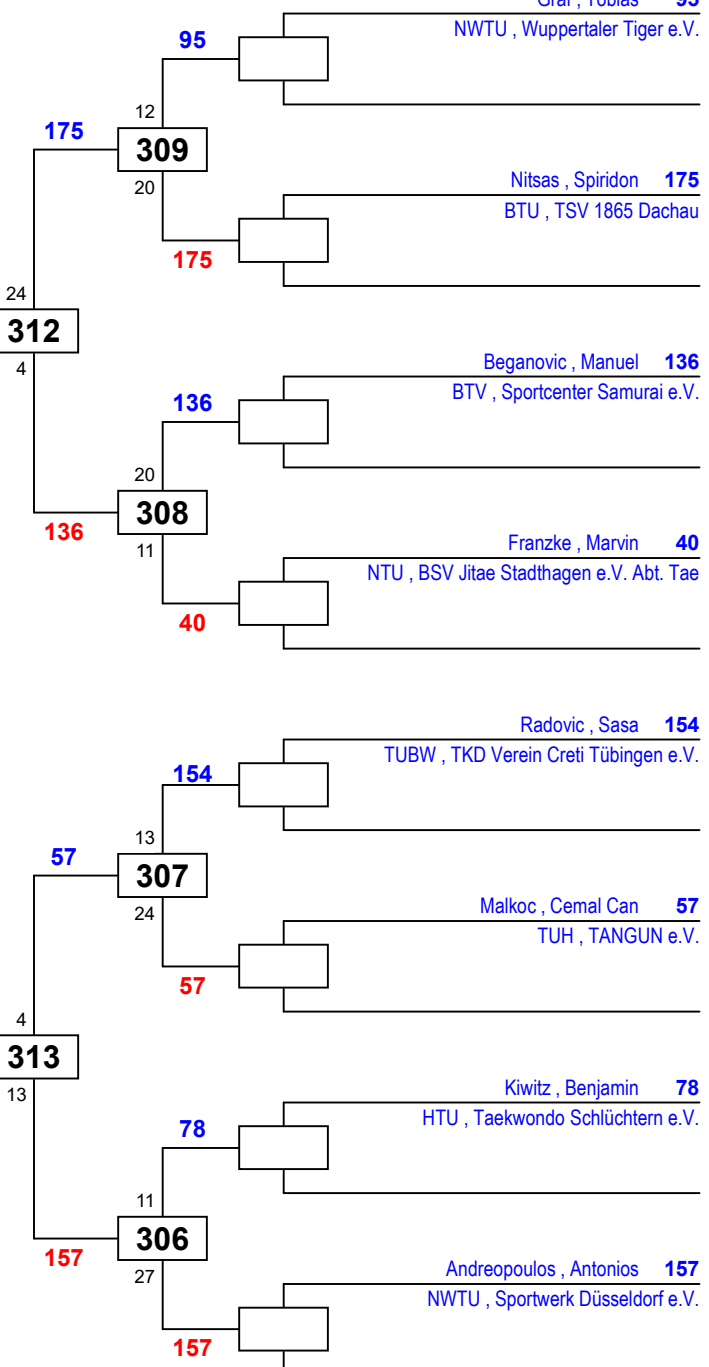



# DEM Jugend A 2017

am 05.02.2017

## J Am-59



### Draw Sheet

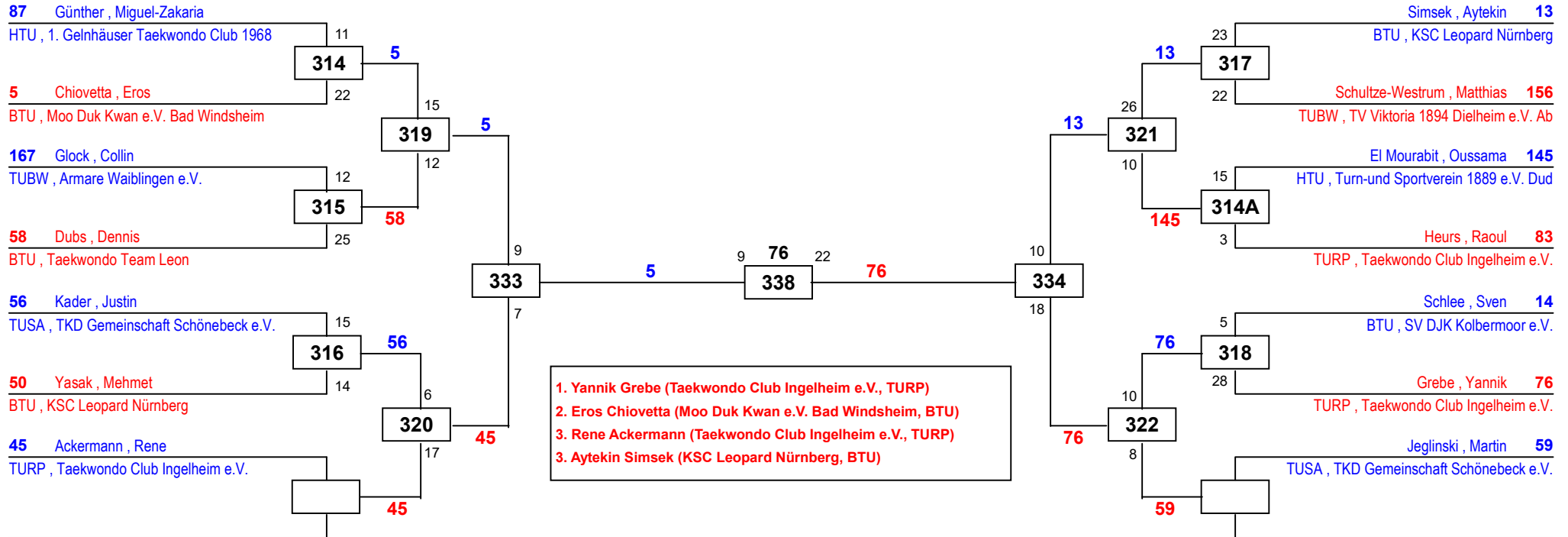



# DEM Jugend A 2017

am 05.02.2017  
J Am-63



## Draw Sheet

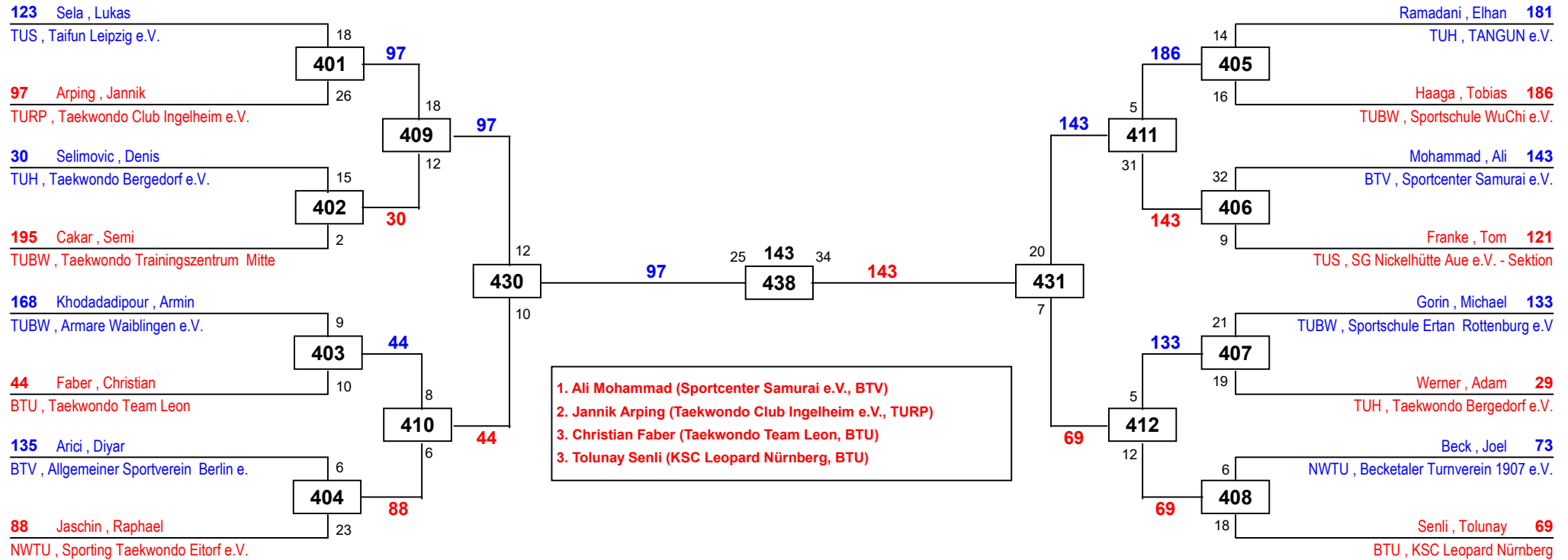



# DEM Jugend A 2017

am 05.02.2017

## J Am-68



### Draw Sheet

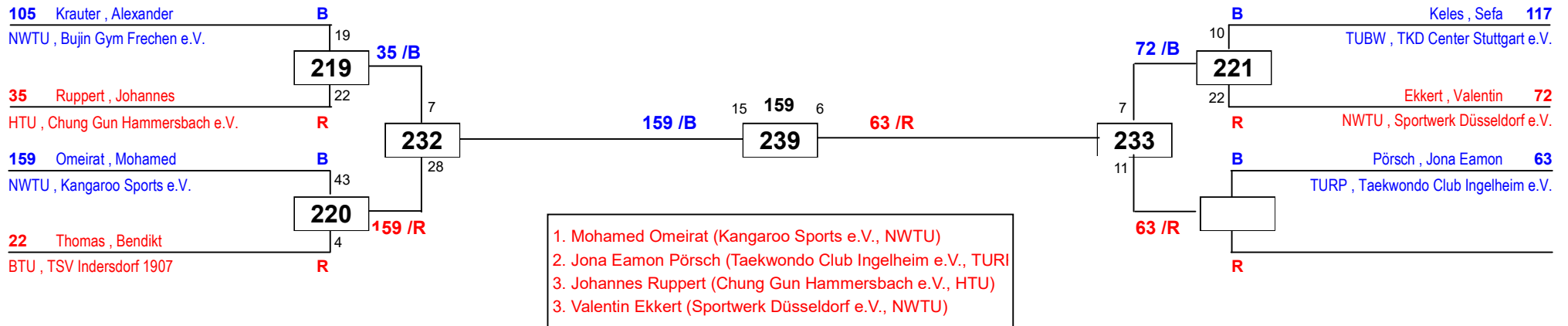

- 1. Mohamed Omeirat (Kangaroo Sports e.V., NWTU)
- 2. Jona Eamon Pörsch (Taekwondo Club Ingelheim e.V., TURI)
- 3. Johannes Ruppert (Chung Gun Hammersbach e.V., HTU)
- 3. Valentin Ekkert (Sportwerk Düsseldorf e.V., NWTU)





# DEM Jugend A 2017

am 05.02.2017  
J Am-73



## Draw Sheet

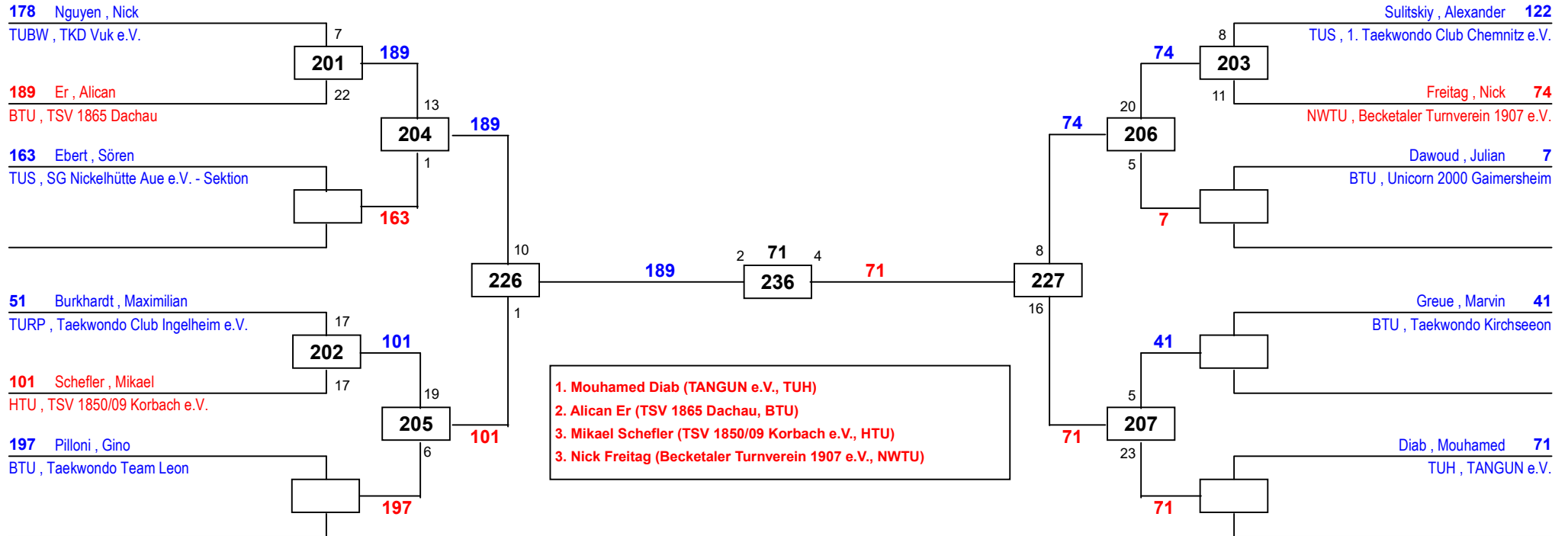



# DEM Jugend A 2017

am 05.02.2017

## J Am-78



### Draw Sheet

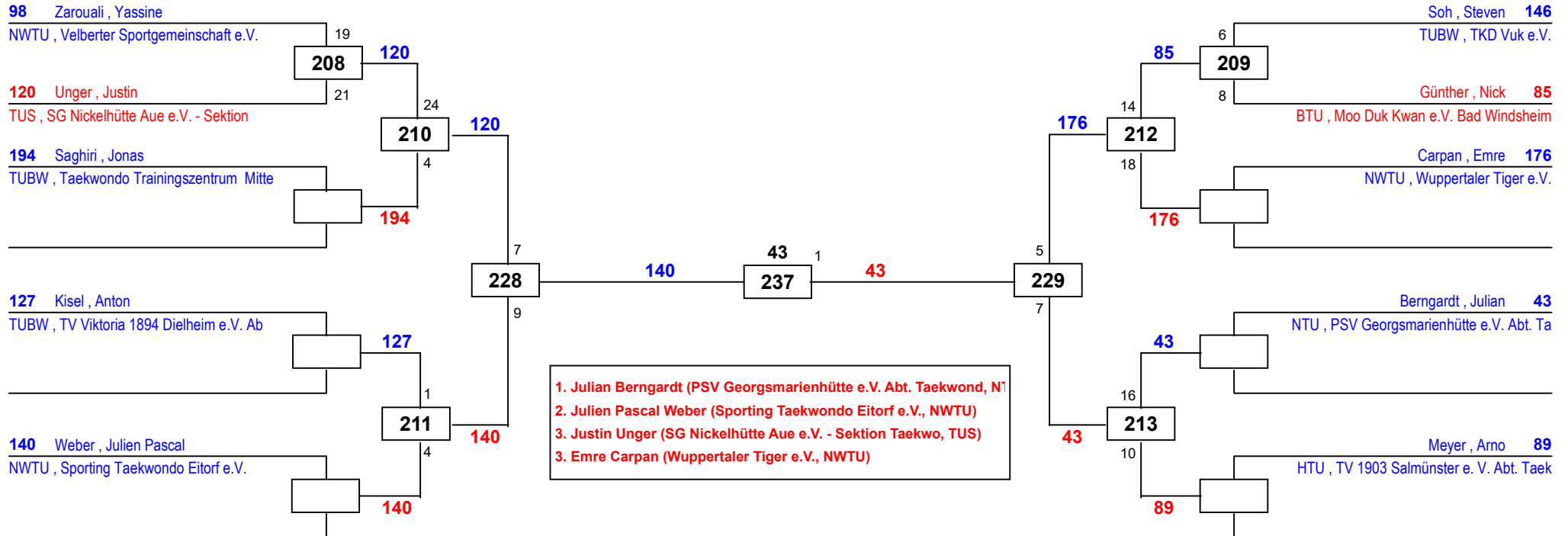



# DEM Jugend A 2017

am 05.02.2017

## J Aw+68



### Draw Sheet

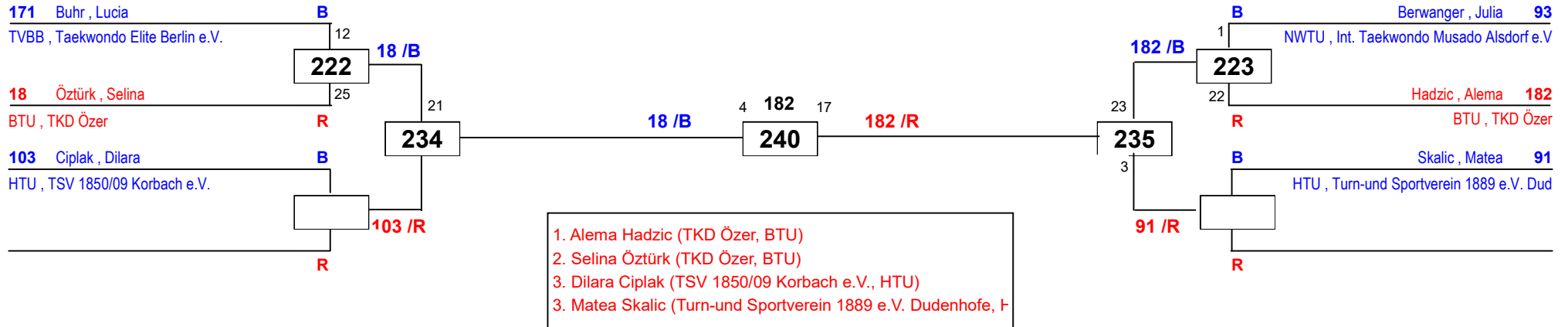



# DEM Jugend A 2017

am 05.02.2017

## J Aw-42



### Draw Sheet

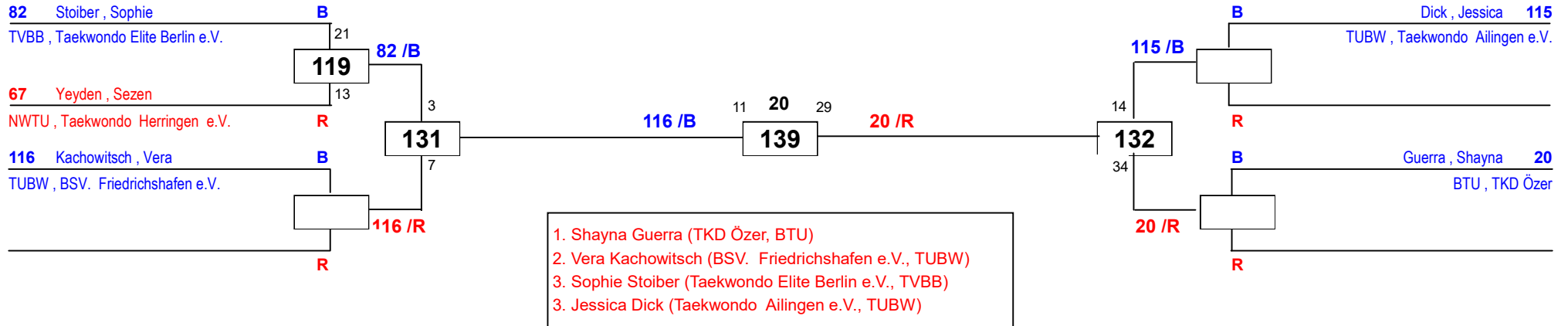



# DEM Jugend A 2017

am 05.02.2017  
J Aw-44



## Draw Sheet

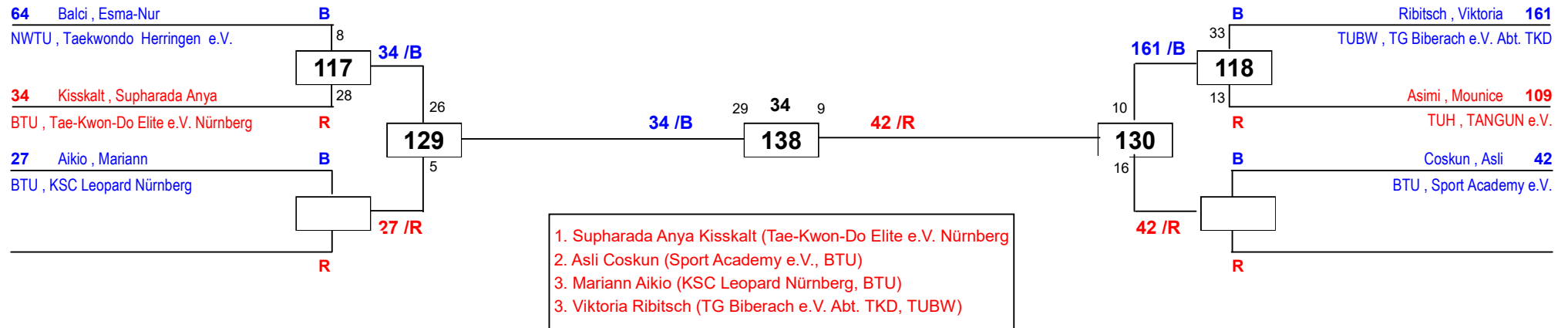



# DEM Jugend A 2017

am 05.02.2017

## J Aw-46



### Draw Sheet

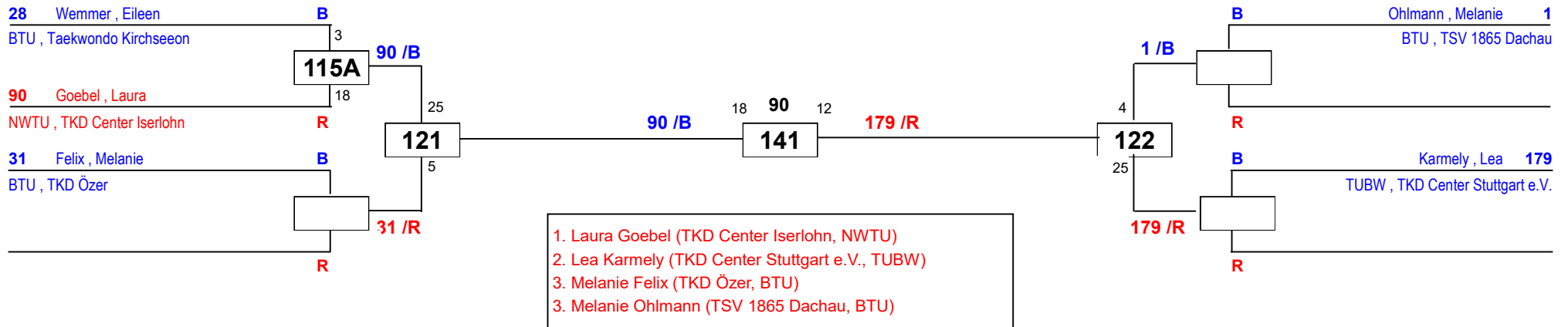



# DEM Jugend A 2017

am 05.02.2017

## J Aw-49



### Draw Sheet

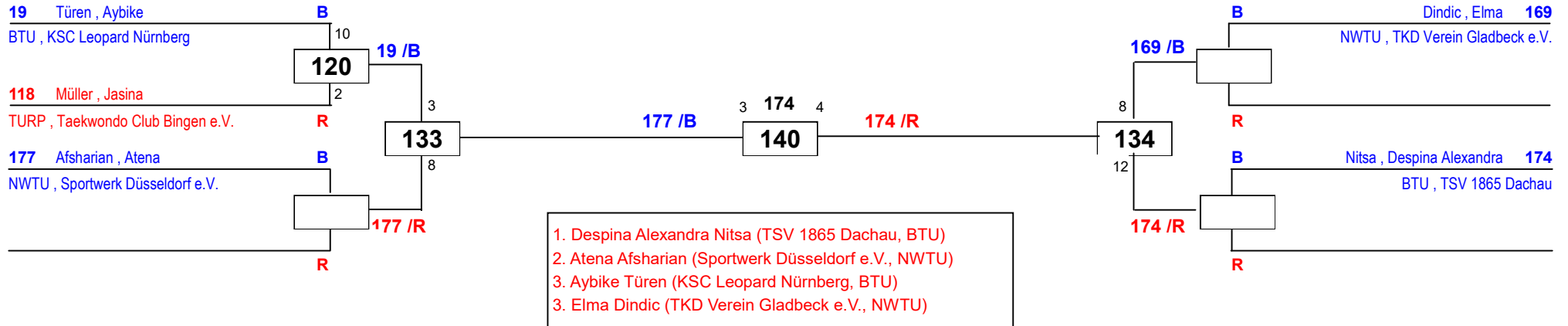



# DEM Jugend A 2017

am 05.02.2017

## J Aw-52



### Draw Sheet

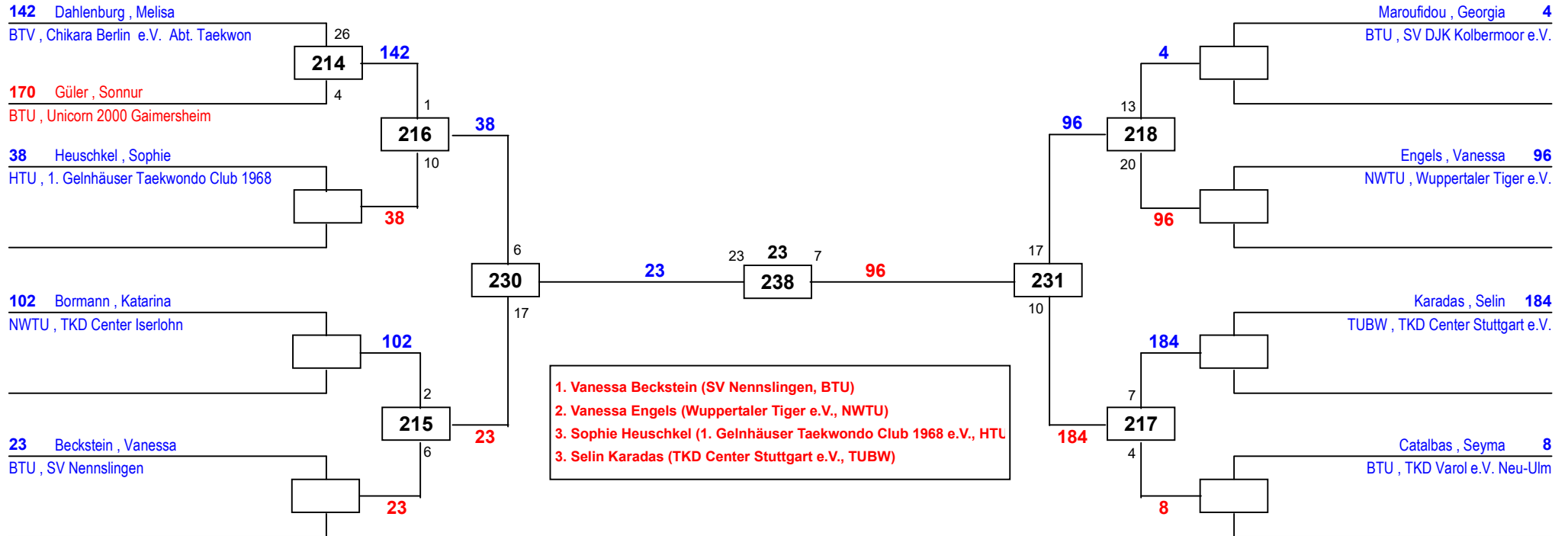





# DEM Jugend A 2017

am 05.02.2017

## J Aw-55



### Draw Sheet

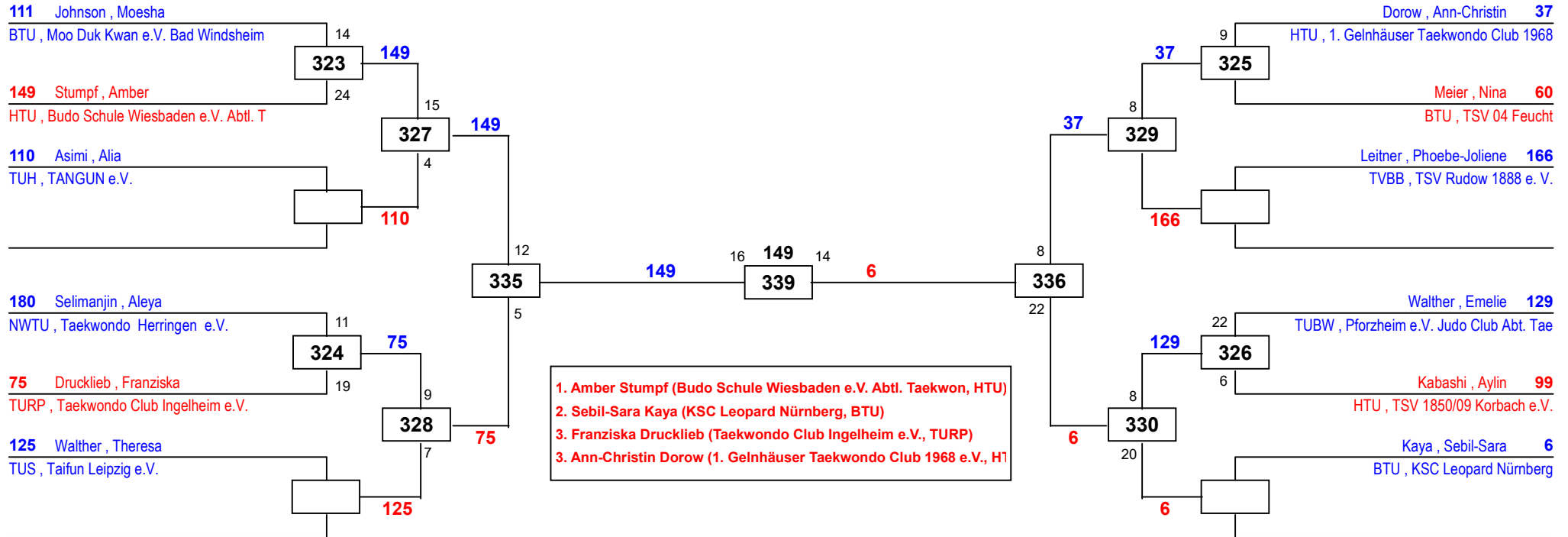



# DEM Jugend A 2017

am 05.02.2017  
J Aw-59



## Draw Sheet

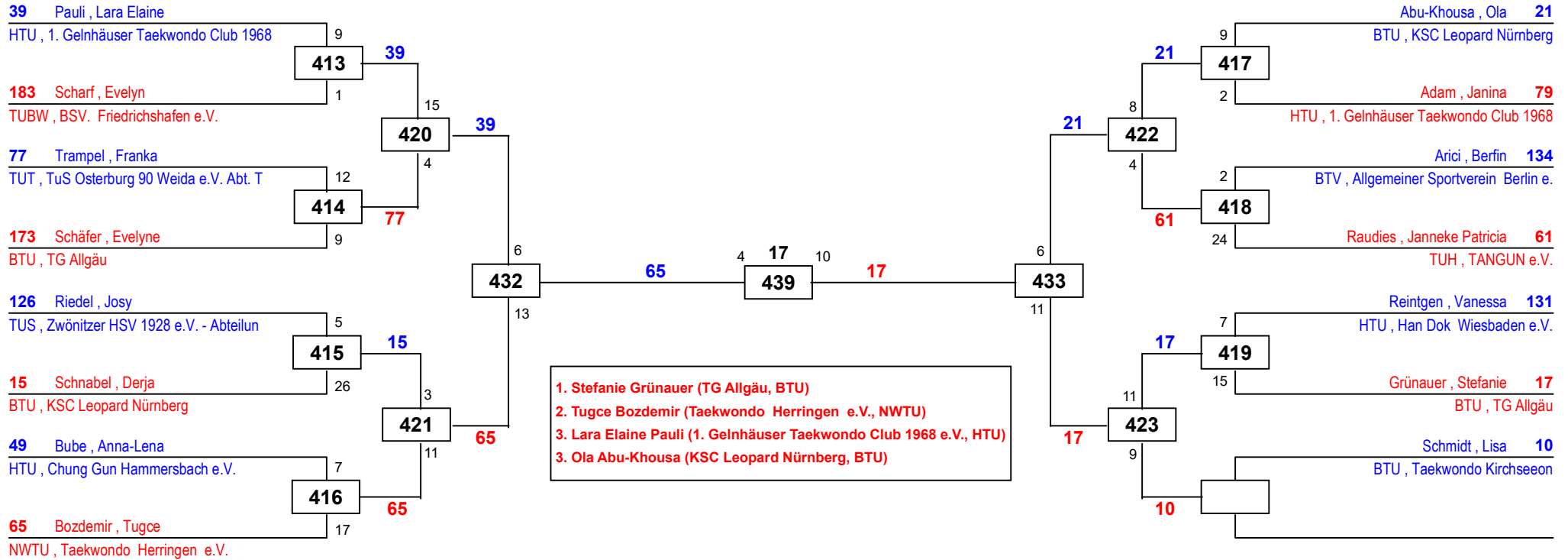



# DEM Jugend A 2017

am 05.02.2017  
J Aw-63



## Draw Sheet

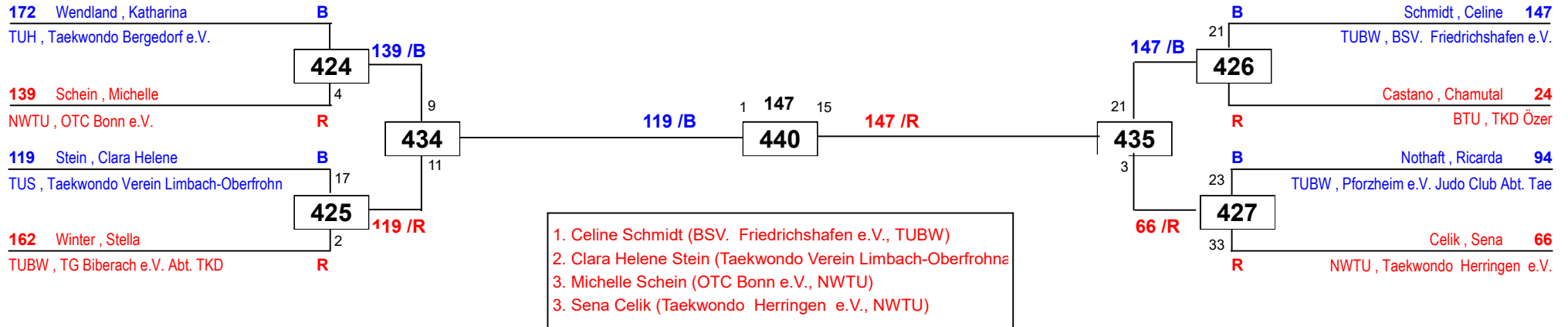



# DEM Jugend A 2017

am 05.02.2017  
J Aw-68



## Draw Sheet

