

8th GALEB BELGRADE TROPHY

Competition Area 4

Children (B) F-21



330 - Stefanov Miljana
[SRB] EUROŠPED

Pučijašević Dejana - 486
[SRB] ELIT

314 - Jović Sara
[SRB] GALEB

Jović Teodora - 308
[SRB] GALEB

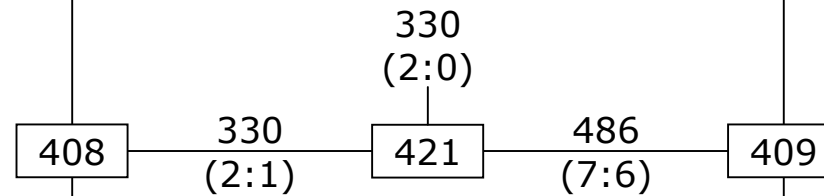

1. Stefanov Miljana ([SRB] EUROŠPED)
2. Pučijašević Dejana ([SRB] ELIT)
3. Jović Teodora ([SRB] GALEB)
3. Jović Sara ([SRB] GALEB)

8th GALEB BELGRADE TROPHY

Competition Area 4

Children (B) F-25



179 - Đorđević Milica
[SRB] LETNJKOVAC

Rezar Eva - 126
[CRO] JASTREB

017 - Maria Nikolaeva Pulina
[BUL] CHO ELITE TAEKWONDO

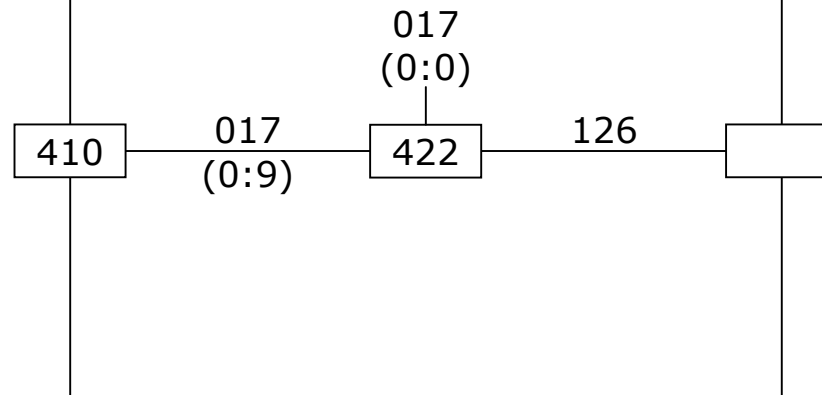

- | |
|---|
| 1. Maria Nikolaeva Pulina ([BUL] CHO ELITE TAEKWONDO) |
| 2. Rezar Eva ([CRO] JASTREB) |
| 3. Đorđević Milica ([SRB] LETNJKOVAC) |
| 3. |

8th GALEB BELGRADE TROPHY

Competition Area 5

Children (B) F-31

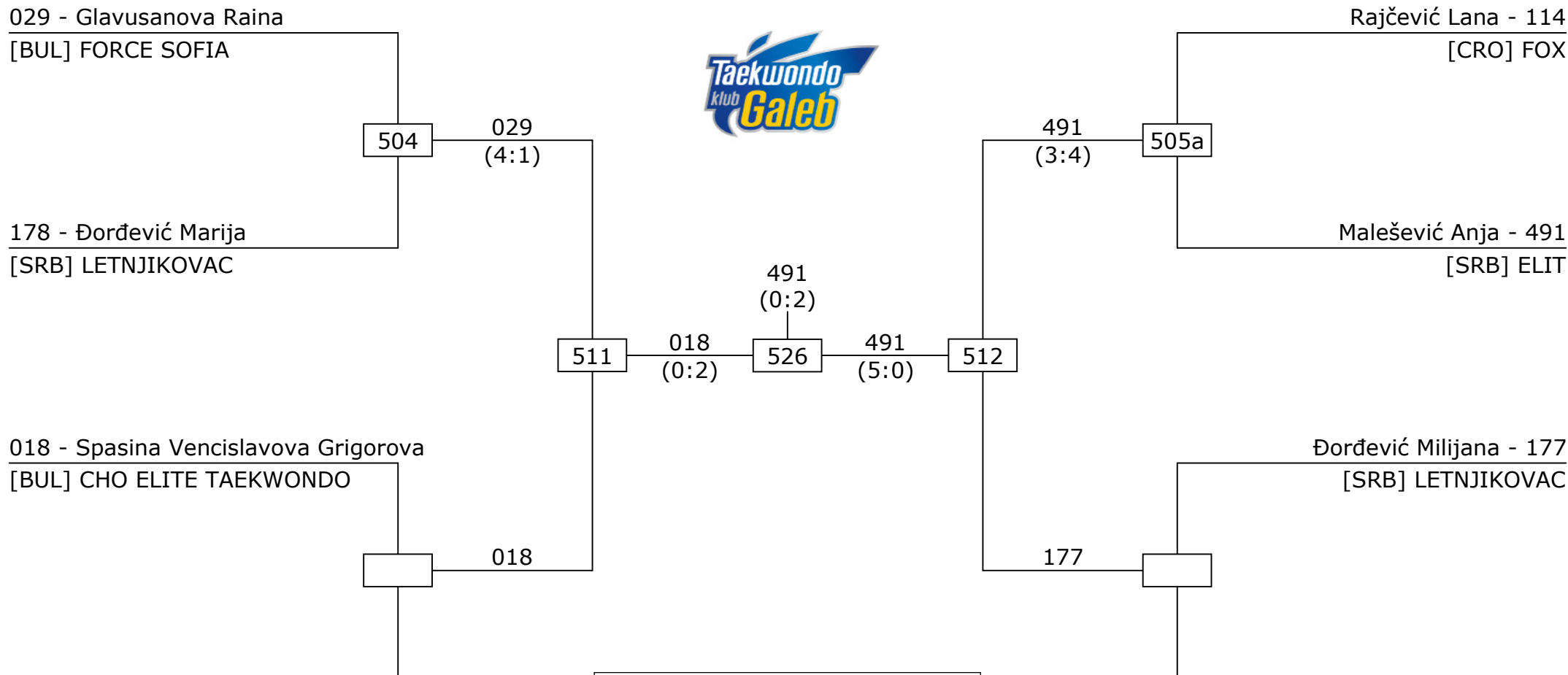

1. Malešević Anja ([SRB] ELIT)
2. Spasina Vencislavova Grigorova ([BUL] CHO ELITE TAEKWONDO)
3. Đorđević Milijana ([SRB] LETNJKOVAC)
3. Glavusanova Raina ([BUL] FORCE SOFIA)

8th GALEB BELGRADE TROPHY

Competition Area 4

Children (B) F-36



103 - Vargova Natalia
[SVK] ILYO

402

301
(0:3)

301 - Mrdja Nina
[SRB] GALEB

180 - Bogdanović Jana
[SRB] LETNJIKOVAC

180

411

301
(7:0)

301
(1:0)

423

305
(1:2)

412

302
(0:4)

403

Mihaljčić Ana - 166
[SRB] CENTAR

Stankovic Vanja - 302
[SRB] GALEB

Savkovic Nadja - 305
[SRB] GALEB

305

- | |
|--|
| 1. Mrdja Nina ([SRB] GALEB) |
| 2. Savkovic Nadja ([SRB] GALEB) |
| 3. Stankovic Vanja ([SRB] GALEB) |
| 3. Bogdanović Jana ([SRB] LETNJIKOVAC) |

8th GALEB BELGRADE TROPHY

Competition Area 4

Children (B) F+40



445 - Milivojević Marija
[SRB] EUROŠPED

Milinčić Nada - 438
[SRB] FENIKS

352 - Marija Pesevska
[MKD] FYR MAKEDONIA

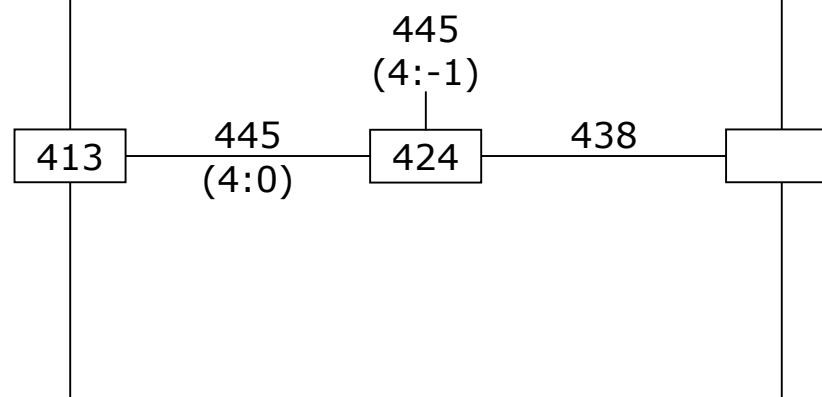

- | |
|--|
| 1. Milivojević Marija ([SRB] EUROŠPED) |
| 2. Milinčić Nada ([SRB] FENIKS) |
| 3. Marija Pesevska ([MKD] FYR MAKEDONIA) |
| 3. |

8th GALEB BELGRADE TROPHY

Competition Area 4

Children (B) M-21



447 - Milosavljević Nemanja
[SRB] EUROŠPED

Varda Vukašin - 446
[SRB] EUROŠPED

028 - Dimitrov Kristian
[BUL] FORCE SOFIA

Adamović Lazar - 514
[SRB] OMEGA

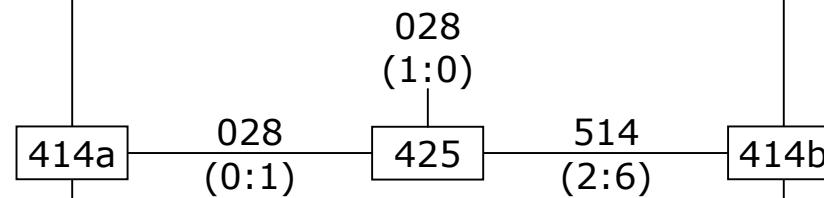

- | |
|---|
| 1. Dimitrov Kristian ([BUL] FORCE SOFIA) |
| 2. Adamović Lazar ([SRB] OMEGA) |
| 3. Varda Vukašin ([SRB] EUROŠPED) |
| 3. Milosavljević Nemanja ([SRB] EUROŠPED) |

8th GALEB BELGRADE TROPHY
Competition Area 5
Children (B) M-23



255 - Kovačević Mihajlo
[SRB] POBEDNIK

465
(0:4)

527

Viktor Kostev - 465
[UKR] UKRAINA

1. Viktor Kostev ([UKR] UKRAINA)
2. Kovačević Mihajlo ([SRB] POBEDNIK)
3.
3.

8th GALEB BELGRADE TROPHY

Competition Area 5

Children (B) M-25



485 - Saranovic Luka
[SRB] GALEB

Bulat Bogdan - 306
[SRB] GALEB

311 - Golovic Aleksa
[SRB] GALEB

Raičković Vedran - 122
[CRO] JASTREB

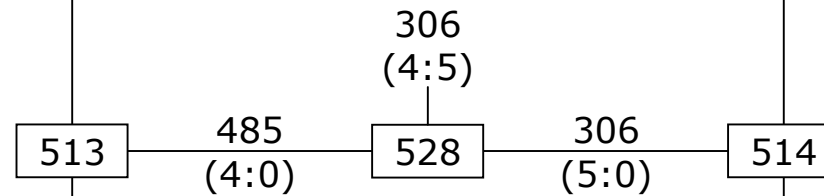

1. Bulat Bogdan ([SRB] GALEB)
2. Saranovic Luka ([SRB] GALEB)
3. Raičković Vedran ([CRO] JASTREB)
3. Golovic Aleksa ([SRB] GALEB)

8th GALEB BELGRADE TROPHY
Competition Area 4
Children (B) M-27

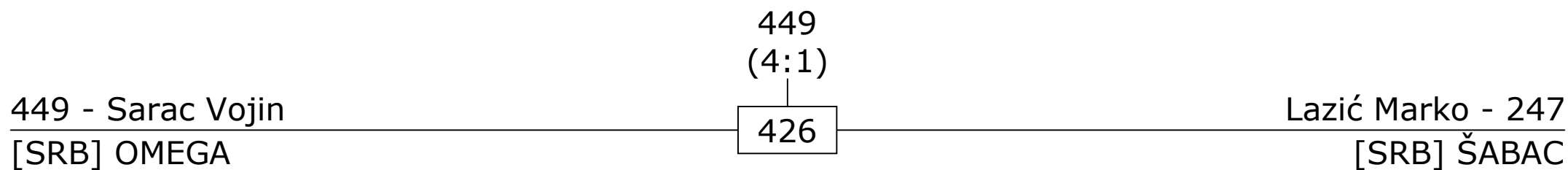

1. Sarac Vojin ([SRB] OMEGA)
2. Lazić Marko ([SRB] ŠABAC)
3.
3.

8th GALEB BELGRADE TROPHY

Competition Area 4

Children (B) M-29



300 - Mrdja Igor
[SRB] GALEB

Risa Alexandru - 082
[ROU] OLIMPIC TAEKWONDO CLUB

124 - Cvijetinović Jan Marić
[CRO] JASTREB

Dimitrijević Matija - 396
[SRB] AZIJA

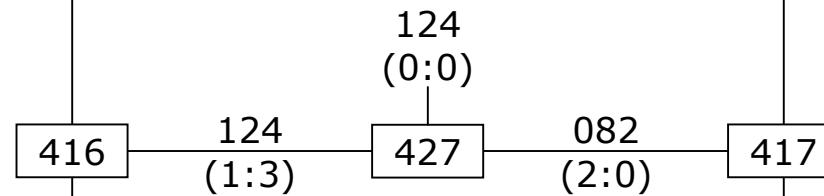

- | |
|--|
| 1. Cvijetinović Jan Marić ([CRO] JASTREB) |
| 2. Risa Alexandru ([ROU] OLIMPIC TAEKWONDO CLUB) |
| 3. Dimitrijević Matija ([SRB] AZIJA) |
| 3. Mrdja Igor ([SRB] GALEB) |

8th GALEB BELGRADE TROPHY

Competition Area 5

Children (B) M-31



307 - Mastilovic Vukota
[SRB] GALEB

Golovic Mihailo - 298
[SRB] GALEB

349 - Hristijan Spasovski
[MKD] FYR MAKEDONIA

Bunčić Filip - 431
[SRB] FENIKS

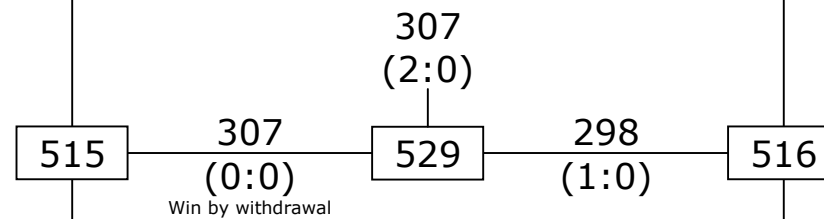

- | |
|--|
| 1. Mastilovic Vukota ([SRB] GALEB) |
| 2. Golovic Mihailo ([SRB] GALEB) |
| 3. Bunčić Filip ([SRB] FENIKS) |
| 3. Hristijan Spasovski ([MKD] FYR MAKEDONIA) |

8th GALEB BELGRADE TROPHY

Competition Area 5

Children (B) M-33



015 - Nikolov Teodor

[BUL] BULGARIAN TAEKWONDO FEDERATION

505b 513
(0:1)

513 - Nenov Teodor

[BUL] BULGARIAN TAEKWONDO FEDERATION

517 513
(3:0)

513
(3:0)

530 450
(0:1)

350

Filip Georgievski - 350

[MKD] FYR MAKEDONIA

252 - Vukašinović Radoš

[SRB] POBEDNIK

252

450

Đurđević Nikola - 450

[SRB] OMEGA

- | |
|--|
| 1. Nenov Teodor ([BUL] BULGARIAN TAEKWONDO FEDERATION) |
| 2. Đurđević Nikola ([SRB] OMEGA) |
| 3. Filip Georgievski ([MKD] FYR MAKEDONIA) |
| 3. Vukašinović Radoš ([SRB] POBEDNIK) |

8th GALEB BELGRADE TROPHY

Competition Area 4

Children (B) M-36

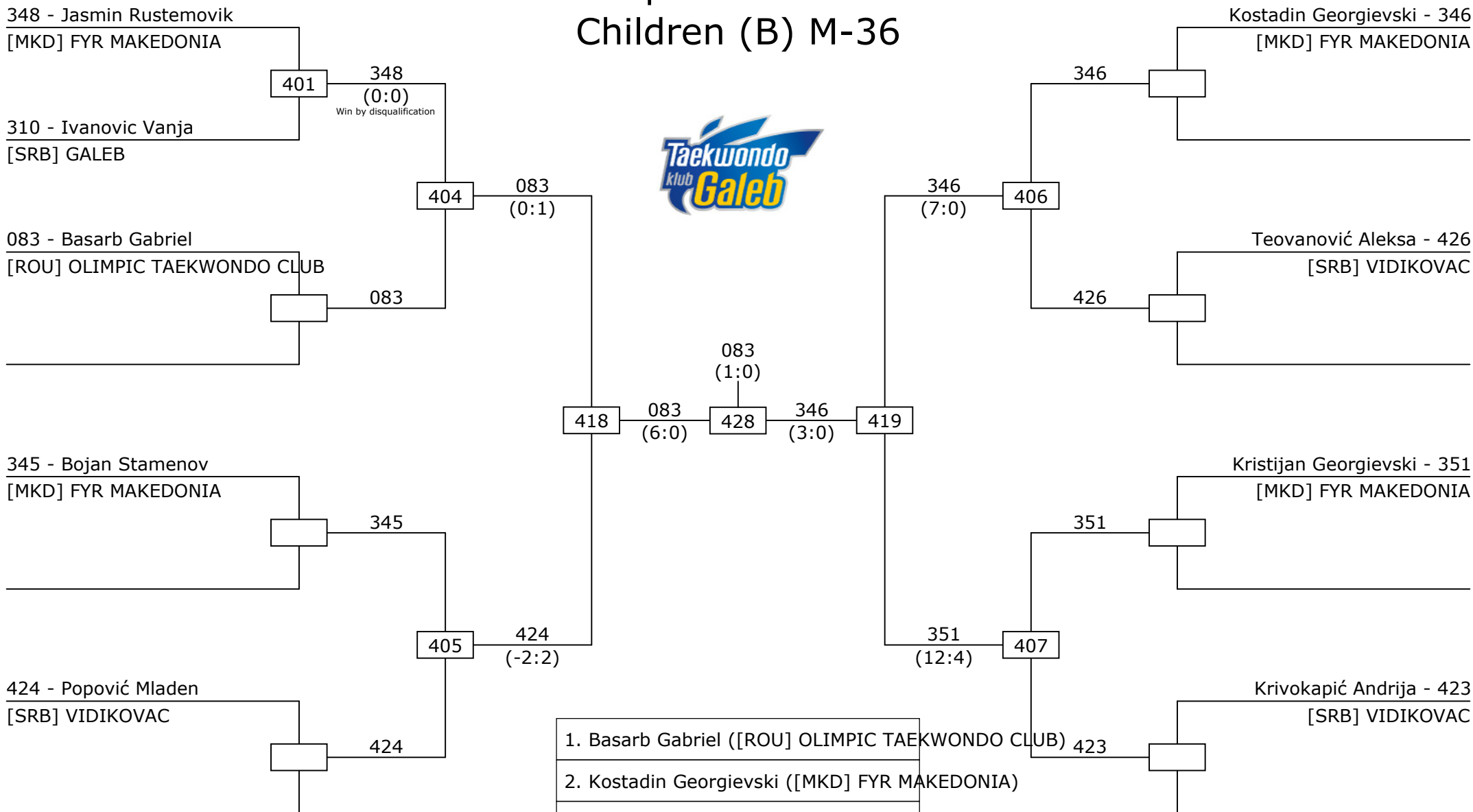

1. Basarb Gabriel ([ROU] OLIMPIC TAEKWONDO CLUB) 423
2. Kostadin Georgievski ([MKD] FYR MAKEDONIA)
3. Kristijan Georgievski ([MKD] FYR MAKEDONIA)
3. Popović Mladen ([SRB] VIDIKOVAC)

8th GALEB BELGRADE TROPHY
Competition Area 4
Children (B) M-40



182 - Stojaković Đorđe [SRB] LETNJKOVAC	182 (4:0) 429	Filip Dodevski - 344 [MKD] FYR MAKEDONIA
--	---------------------	---

1. Stojaković Đorđe ([SRB] LETNJKOVAC)
2. Filip Dodevski ([MKD] FYR MAKEDONIA)
3.
3.

8th GALEB BELGRADE TROPHY

Competition Area 5

Children (B) M+40

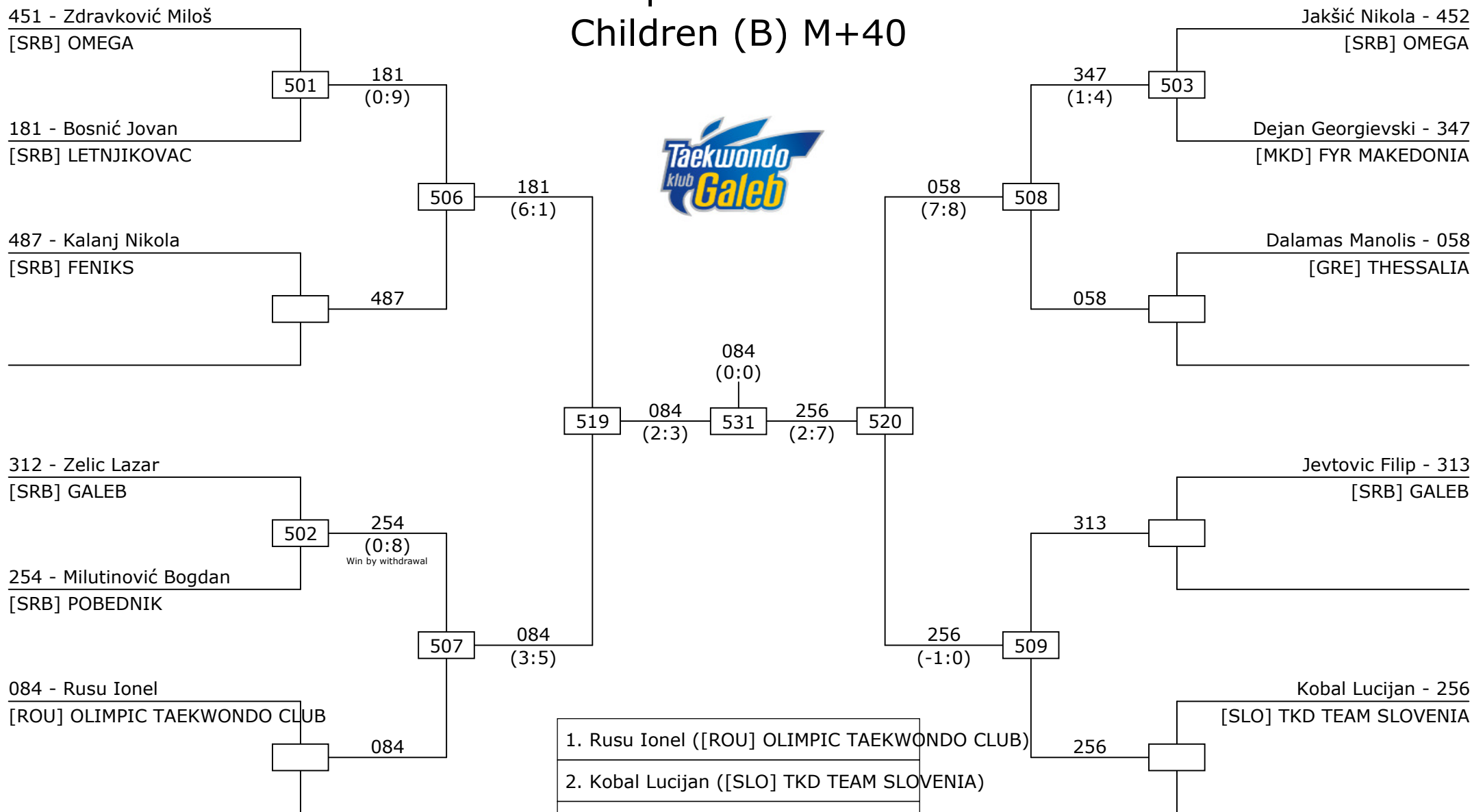

8th GALEB BELGRADE TROPHY
Competition Area 4
Children (A) F-23



251 - Ćirić Anđela
[SRB] POBEDNIK

315
(2:4)

450

Rosić Nađa - 315
[SRB] VINER ČIVI

1. Rosić Nađa ([SRB] VINER ČIVI)

2. Ćirić Anđela ([SRB] POBEDNIK)

3.

3.

8th GALEB BELGRADE TROPHY

Competition Area 4

Children (A) F-29



144 - Perković Jelena
[CRO] ORION

Turnova Ivana - 030
[BUL] FORCE SOFIA

316 - Đorić Irena
[SRB] VINER ČIVI

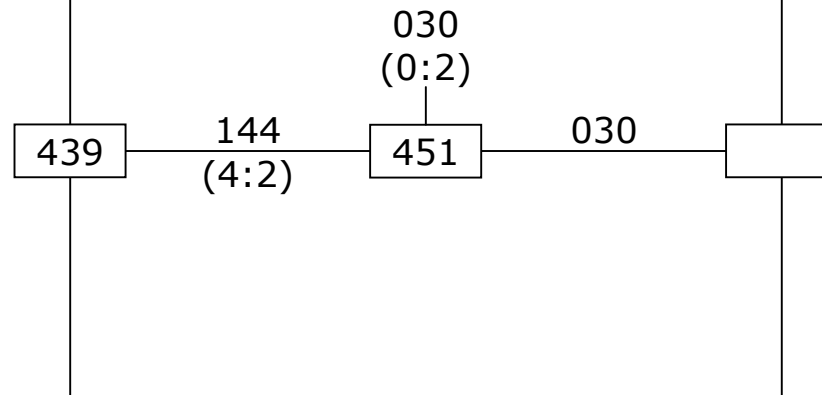

1. Turnova Ivana ([BUL] FORCE SOFIA)
2. Perković Jelena ([CRO] ORION)
3. Đorić Irena ([SRB] VINER ČIVI)
3.

8th GALEB BELGRADE TROPHY
Competition Area 5
Children (A) F-31



317 - Vasić Sara
[SRB] VINER ČIVI

143
(0:9)

551

Matošević Sara - 143
[CRO] ORION

1. Matošević Sara ([CRO] ORION)
2. Vasić Sara ([SRB] VINER ČIVI)
3.
3.

8th GALEB BELGRADE TROPHY
Competition Area 5
Children (A) F-33



304 - Bogdanovic Tijana
[SRB] GALEB

304
(4:2)

552

Šaravanja Ana - 224
[CRO] RUGVICA

1. Bogdanovic Tijana ([SRB] GALEB)
2. Šaravanja Ana ([CRO] RUGVICA)
3.
3.

8th GALEB BELGRADE TROPHY

Competition Area 4

Children (A) F-36



405 - Ruljić Jana
[SRB] AZIJA

Marković Vanja - 318
[SRB] VINER ČIVI

303 - Popova Tasia
[SRB] GALEB

Matošević Danijela - 142
[CRO] ORION

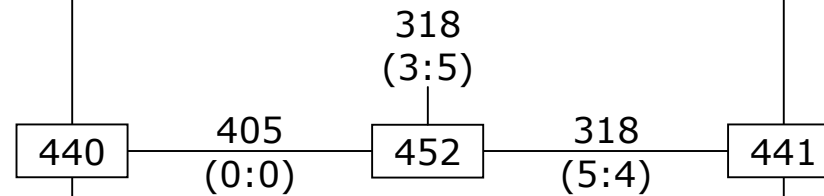

- | |
|--------------------------------------|
| 1. Marković Vanja ([SRB] VINER ČIVI) |
| 2. Ruljić Jana ([SRB] AZIJA) |
| 3. Matošević Danijela ([CRO] ORION) |
| 3. Popova Tasia ([SRB] GALEB) |

8th GALEB BELGRADE TROPHY
Competition Area 5
Children (A) M-21



443 - Milivojević Miloš
[SRB] EUROŠPED

553

Adamović Lazar - 453
[SRB] OMEGA

1.
2.
3.
3.

8th GALEB BELGRADE TROPHY

Competition Area 5

Children (A) M-27



415 - Husić Nedžad
[BIH] NOVI GRAD

Yiannakou Antreas - 238
[CYP] MAKEDONIA

510 - Milivojević Miloš
[SRB] EUROŠPED

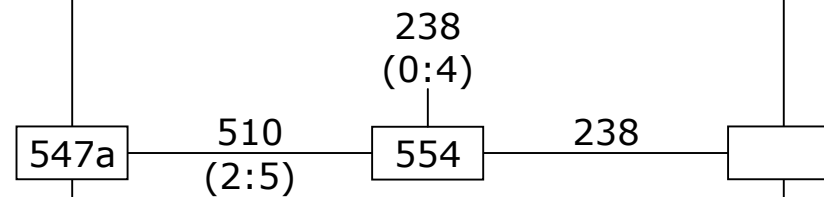

- | |
|--|
| 1. Yiannakou Antreas ([CYP] MAKEDONIA) |
| 2. Milivojević Miloš ([SRB] EUROŠPED) |
| 3. Husić Nedžad ([BIH] NOVI GRAD) |
| 3. |

8th GALEB BELGRADE TROPHY

Competition Area 4

Children (A) M-29

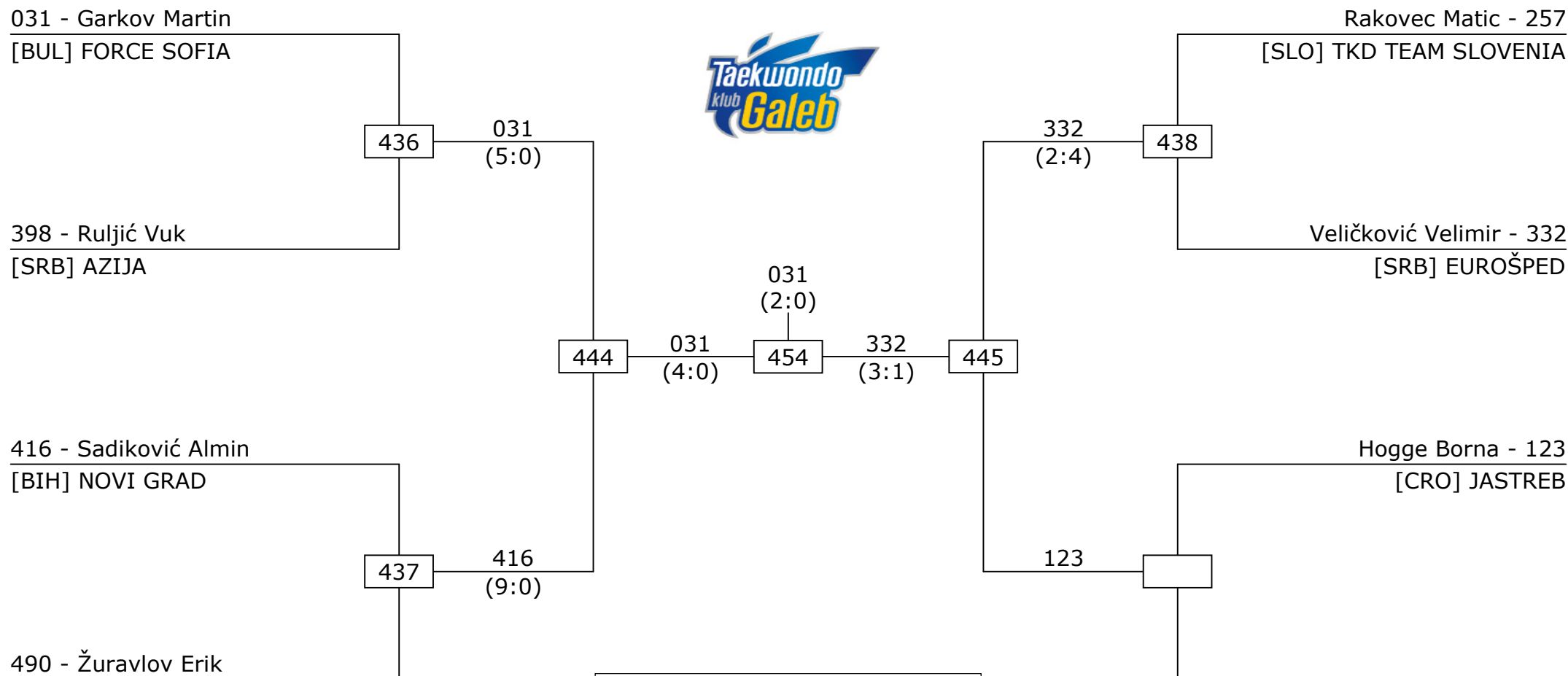

- | |
|--|
| 1. Garkov Martin ([BUL] FORCE SOFIA) |
| 2. Veličković Velimir ([SRB] EUROŠPED) |
| 3. Hogge Borna ([CRO] JASTREB) |
| 3. Sadiković Almin ([BIH] NOVI GRAD) |

8th GALEB BELGRADE TROPHY

Competition Area 4

Children (A) M-33



333 - Ivković Filip
[SRB] EUROŠPED

Burean Man - 210
[ROU] ROMANIAN TKD FED.

109 - Nikolić Filip
[SRB] KWON

Dimič Aljaž - 258
[SLO] TKD TEAM SLOVENIA

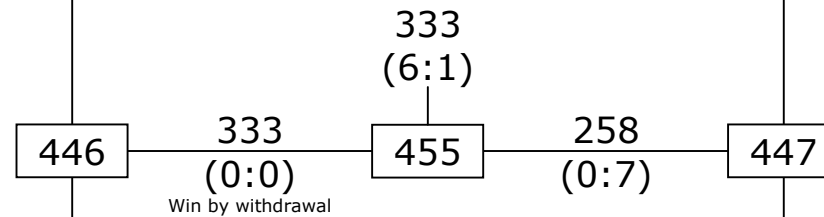

- | |
|--|
| 1. Ivković Filip ([SRB] EUROŠPED) |
| 2. Dimič Aljaž ([SLO] TKD TEAM SLOVENIA) |
| 3. Burean Man ([ROU] ROMANIAN TKD FED.) |
| 3. Nikolić Filip ([SRB] KWON) |

8th GALEB BELGRADE TROPHY

Competition Area 5

Children (A) M-36

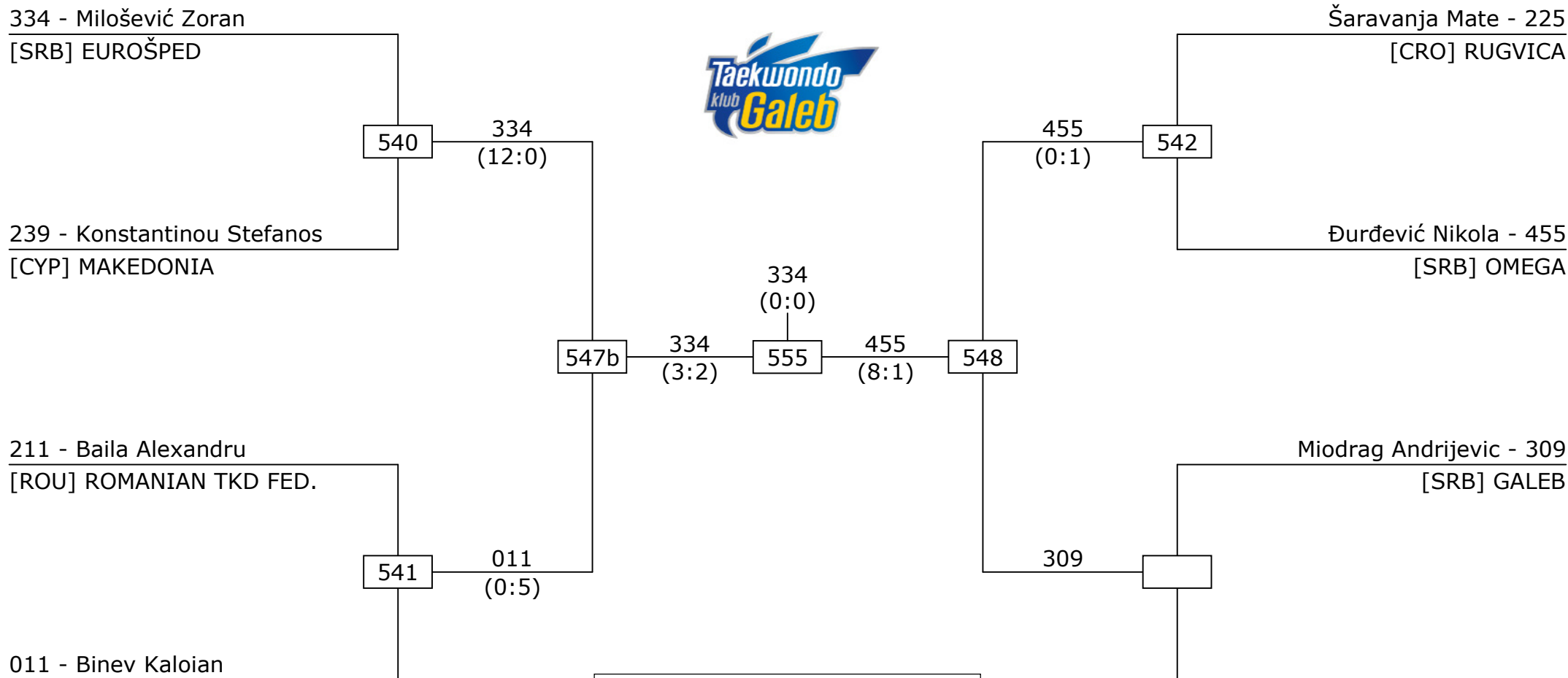

- | |
|---|
| 1. Milošević Zoran ([SRB] EUROŠPED) |
| 2. Đurđević Nikola ([SRB] OMEGA) |
| 3. Miodrag Andrijevic ([SRB] GALEB) |
| 3. Binev Kaloian ([BUL] BULGARIAN TAEKWONDO FEDERATION) |

8th GALEB BELGRADE TROPHY

Competition Area 5

Children (A) M-40

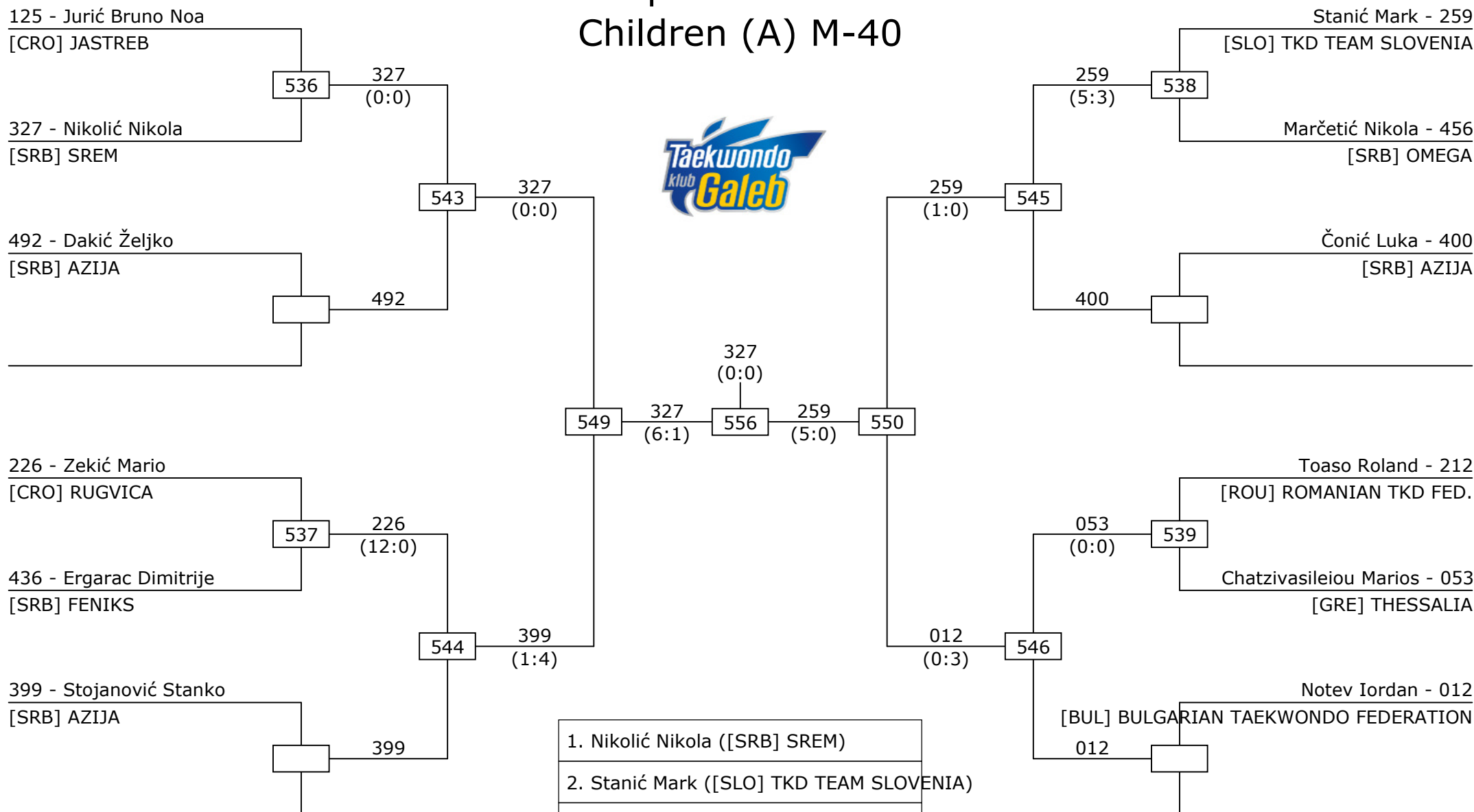

- | |
|--|
| 1. Nikolić Nikola ([SRB] SREM) |
| 2. Stanić Mark ([SLO] TKD TEAM SLOVENIA) |
| 3. Notev Jordan ([BUL] BULGARIAN TAEKWONDO FEDERATION) |
| 3. Stojanović Stanko ([SRB] AZIJA) |

8th GALEB BELGRADE TROPHY

Competition Area 4

Children (A) M+40



127 - Majić Ivan Tvrtko
[CRO] JASTREB

Pavlović Igor - 401
[SRB] AZIJA

404 - Bakračevski Konstantin
[SRB] AZIJA

Tohidi Araš - 328
[SRB] SREM

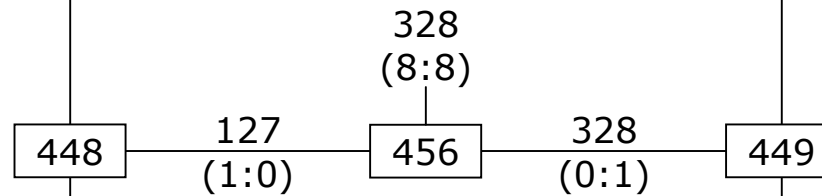

- | |
|---|
| 1. Tohidi Araš ([SRB] SREM) |
| 2. Majić Ivan Tvrtko ([CRO] JASTREB) |
| 3. Pavlović Igor ([SRB] AZIJA) |
| 3. Bakračevski Konstantin ([SRB] AZIJA) |

8th GALEB BELGRADE TROPHY

Competition Area 5

Cadet (B) F-47



020 - Iordanova Maria
[BUL] FORCE 1992

Nikolić Jovana - 110
[SRB] KWON

384 - Tanasić Zorana
[BIH] SOKOL

Vilotijević Jovana - 434
[SRB] FENIKS

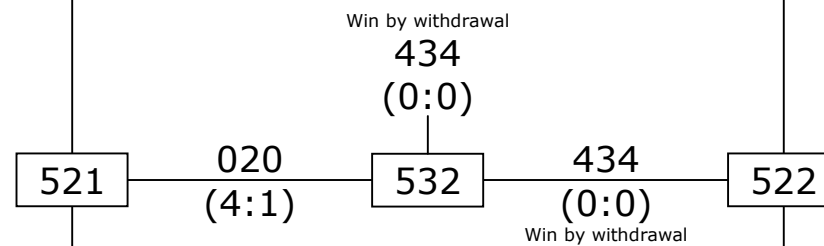

- | |
|---------------------------------------|
| 1. Vilotijević Jovana ([SRB] FENIKS) |
| 2. Iordanova Maria ([BUL] FORCE 1992) |
| 3. Nikolić Jovana ([SRB] KWON) |
| 3. Tanasić Zorana ([BIH] SOKOL) |

8th GALEB BELGRADE TROPHY

Competition Area 4

Cadet (B) F-59



391 - Borodenko Sonja
[SRB] BEOGRAD

Mikova Timea - 098
[SVK] ILYO

435 - Marinković Tamara
[SRB] FENIKS

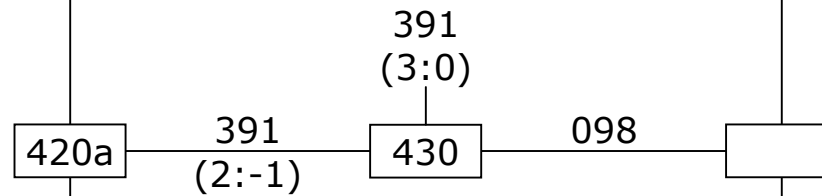

- | |
|-------------------------------------|
| 1. Borodenko Sonja ([SRB] BEOGRAD) |
| 2. Mikova Timea ([SVK] ILYO) |
| 3. Marinković Tamara ([SRB] FENIKS) |
| 3. |

8th GALEB BELGRADE TROPHY
Competition Area 4
Cadet (B) M-37



148 - Galović Domagoj [CRO] ŠKORPION	148 (0:0) 431	Zlatev Martin - 019 [BUL] FORCE 1992
---	---------------------	---

1. Galović Domagoj ([CRO] ŠKORPION)
2. Zlatev Martin ([BUL] FORCE 1992)
3.
3.

8th GALEB BELGRADE TROPHY

Competition Area 5

Cadet (B) M-41



184 - Knežević Luka
[SRB] LETNJKOVAC

Vićentić Miodrag - 183
[SRB] LETNJKOVAC

393 - Veličković Luka
[SRB] BEOGRAD

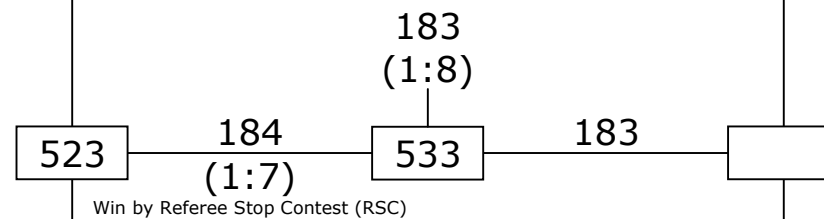

- | |
|--|
| 1. Vićentić Miodrag ([SRB] LETNJKOVAC) |
| 2. Knežević Luka ([SRB] LETNJKOVAC) |
| 3. Veličković Luka ([SRB] BEOGRAD) |
| 3. |

8th GALEB BELGRADE TROPHY

Competition Area 5

Cadet (B) M-45

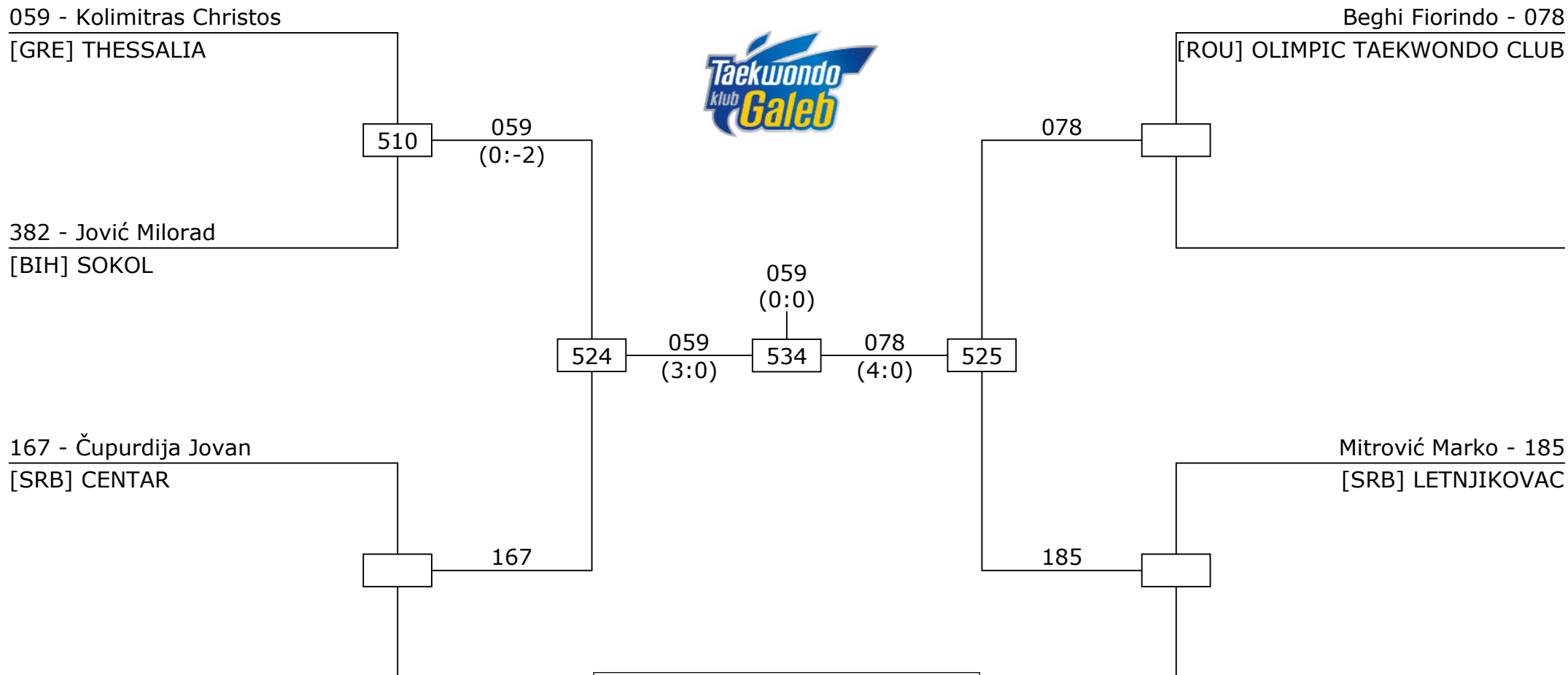

- | |
|--|
| 1. Kolimitras Christos ([GRE] THESSALIA) |
| 2. Beghi Fiorindo ([ROU] OLIMPIC TAEKWONDO CLUB) |
| 3. Mitrović Marko ([SRB] LETNJKOVAC) |
| 3. Čupurdija Jovan ([SRB] CENTAR) |

8th GALEB BELGRADE TROPHY
Competition Area 4
Cadet (B) M-49



021 - Kanchev Mihail
[BUL] FORCE 1992

021
(1:0)

432

Dujaković Marin - 149
[CRO] ŠKORPION

1. Kanchev Mihail ([BUL] FORCE 1992)
2. Dujaković Marin ([CRO] ŠKORPION)
3.
3.

8th GALEB BELGRADE TROPHY

Competition Area 4

Cadet (B) M-61



499 - Skočić Oliver
[CRO] KONDOR

Đorđevski Miran - 112
[CRO] CROSTAR

511 - Onaca Adrian
[ROU] OLIMPIC TAEKWONDO CLUB

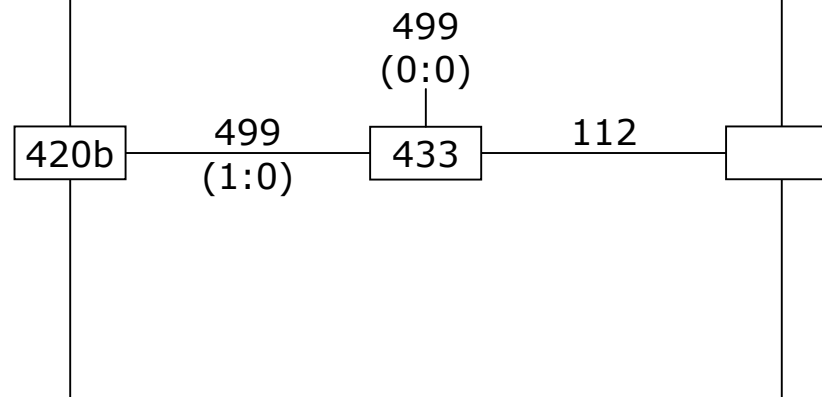

1. <u>Skočić Oliver</u> ([CRO] KONDOR)
2. <u>Đorđevski Miran</u> ([CRO] CROSTAR)
3. <u>Onaca Adrian</u> ([ROU] OLIMPIC TAEKWONDO CLUB)
3.

8th GALEB BELGRADE TROPHY

Competition Area 1

Cadet (A) F-37



036 - Stoykova Felisiti
[BUL] FORCE SOFIA

102 036
(4:1)

151 - Rumenjak Magdalena
[CRO] ŠKORPION

132

132 - Ljubanović Maja
[CRO] KONDOR

113 132
(2:3)

132
(0:0)

126 034
(3:2)

034
(2:0) 103

Tsvetkova Kristina - 034
[BUL] FORCE SOFIA

Montemurro Rebecca - 161
[ITA] HWARANG SPORTING CLUB

131

Blatančić Marija - 131
[CRO] KONDOR

114

- | |
|---|
| 1. Ljubanović Maja ([CRO] KONDOR) |
| 2. Tsvetkova Kristina ([BUL] FORCE SOFIA) |
| 3. Blatančić Marija ([CRO] KONDOR) |
| 3. Stoykova Felisiti ([BUL] FORCE SOFIA) |

8th GALEB BELGRADE TROPHY

Competition Area 1

Cadet (A) F-41

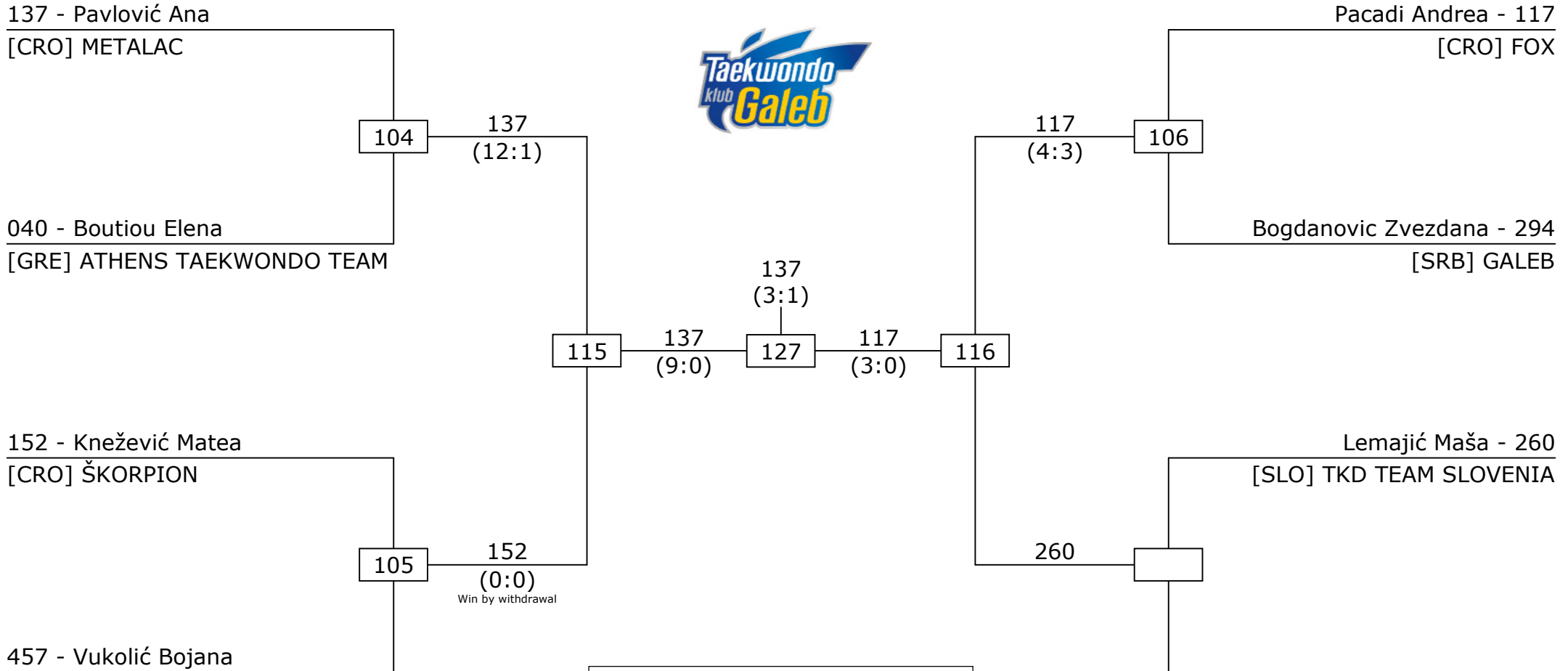

- | |
|---|
| 1. Pavlović Ana ([CRO] METALAC) |
| 2. Pacadi Andrea ([CRO] FOX) |
| 3. Lemajić Maša ([SLO] TKD TEAM SLOVENIA) |
| 3. Knežević Matea ([CRO] ŠKORPION) |

8th GALEB BELGRADE TROPHY

Competition Area 1

Cadet (A) F-44



383 - Cvijetinović Maja
[BIH] SOKOL

Tsantukla Apostolia - 042
[GRE] ATHENS TAEKWONDO TEAM

261 - Kadič Klara
[SLO] TKD TEAM SLOVENIA

Novak Anja - 262
[SLO] TKD TEAM SLOVENIA

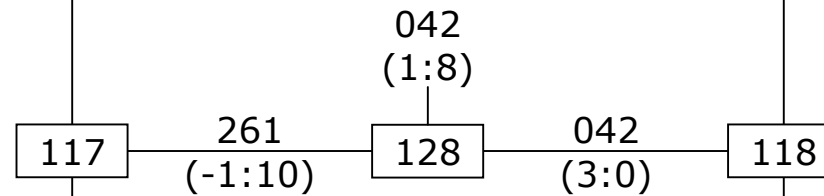

- | |
|--|
| 1. Tsantukla Apostolia ([GRE] ATHENS TAEKWONDO TEAM) |
| 2. Kadič Klara ([SLO] TKD TEAM SLOVENIA) |
| 3. Novak Anja ([SLO] TKD TEAM SLOVENIA) |
| 3. Cvijetinović Maja ([BIH] SOKOL) |

8th GALEB BELGRADE TROPHY

Competition Area 2

Cadet (A) F-47



336 - Perišić Marija
[SRB] EUROŠPED

Baronić Iva - 118
[CRO] FOX

153 - Ružička Elena
[CRO] ŠKORPION

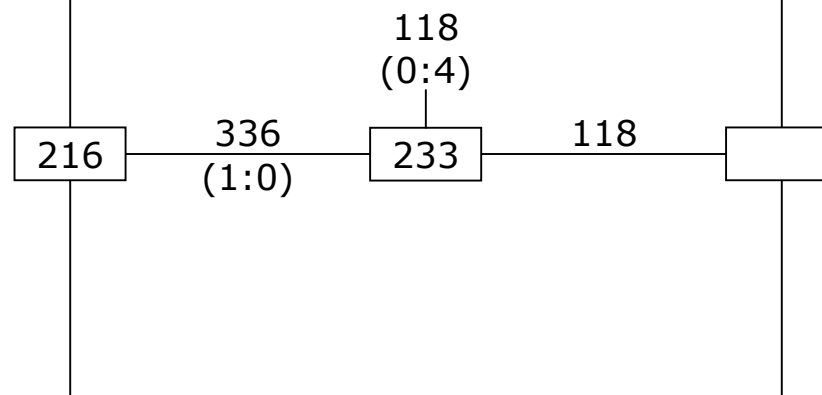

1. Baronić Iva ([CRO] FOX)
2. Perišić Marija ([SRB] EUROŠPED)
3. Ružička Elena ([CRO] ŠKORPION)
3.

8th GALEB BELGRADE TROPHY

Competition Area 2

Cadet (A) F-51



154 - Dijaković Klaudia
[CRO] ŠKORPION

Subašić Jovana - 437
[SRB] FENIKS

263 - Petrušić Ana
[SLO] TKD TEAM SLOVENIA

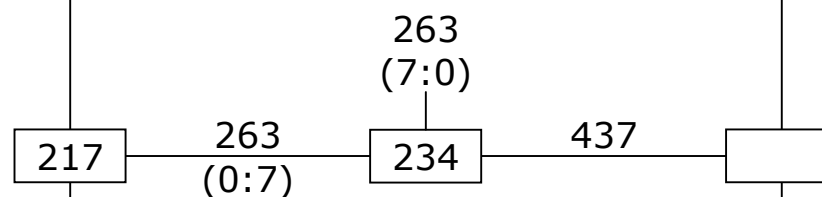

1. Petrušić Ana ([SLO] TKD TEAM SLOVENIA)
2. Subašić Jovana ([SRB] FENIKS)
3. Dijaković Klaudia ([CRO] ŠKORPION)
3.

8th GALEB BELGRADE TROPHY

Competition Area 2

Cadet (A) F-55

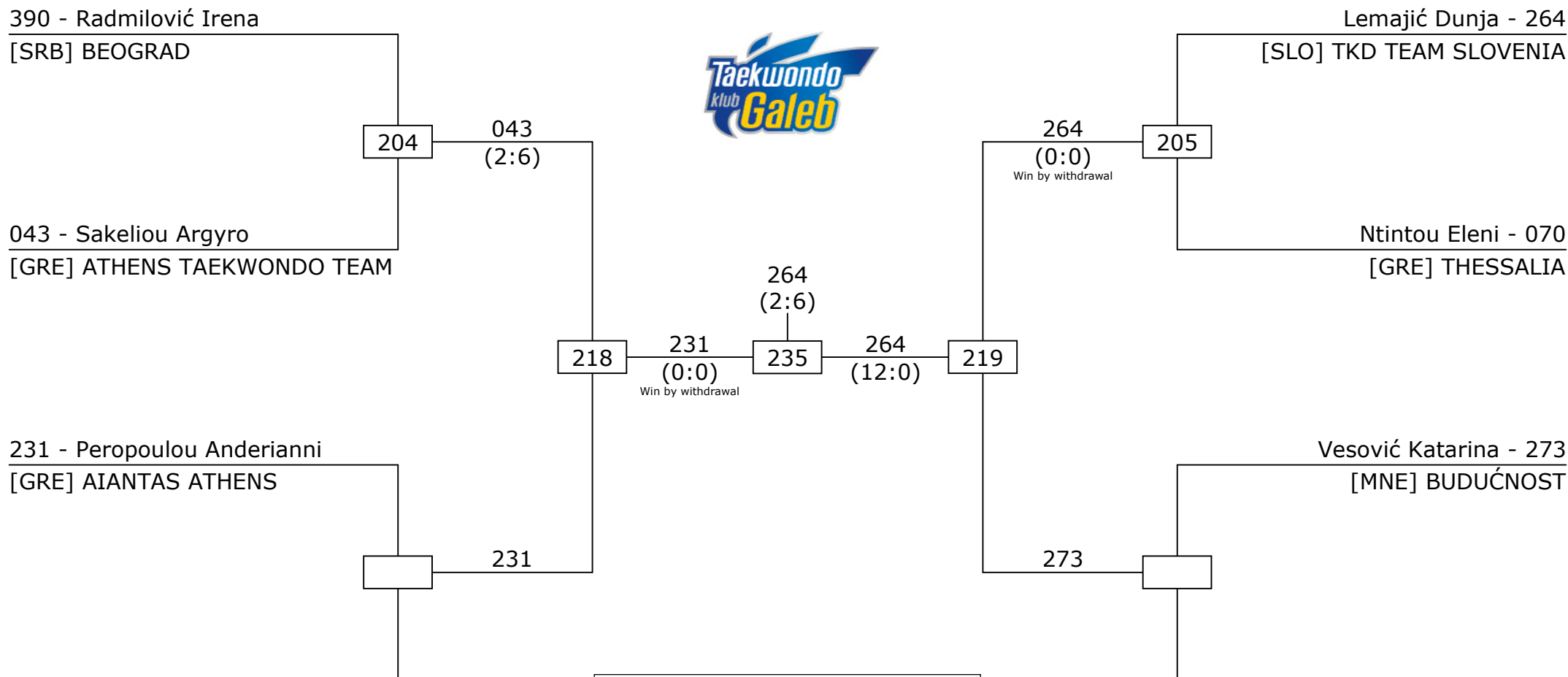

1. Lemajić Dunja ([SLO] TKD TEAM SLOVENIA)
2. Peropoulou Anderianni ([GRE] AIANTAS ATHENS)
3. Vesović Katarina ([MNE] BUDUĆNOST)
3. Sakeliou Argyro ([GRE] ATHENS TAEKWONDO TEAM)

8th GALEB BELGRADE TROPHY

Competition Area 3

Cadet (A) F+59



272 - Popović Anđela
[MNE] BUDUĆNOST

Martić Mateja - 134
[CRO] KONDOR

155 - Rumenjak Gabrijela
[CRO] ŠKORPION

054 - Vlachou Maria
[GRE] THESSALIA

Ntintou Theodora - 507
[GRE] THESSALIA

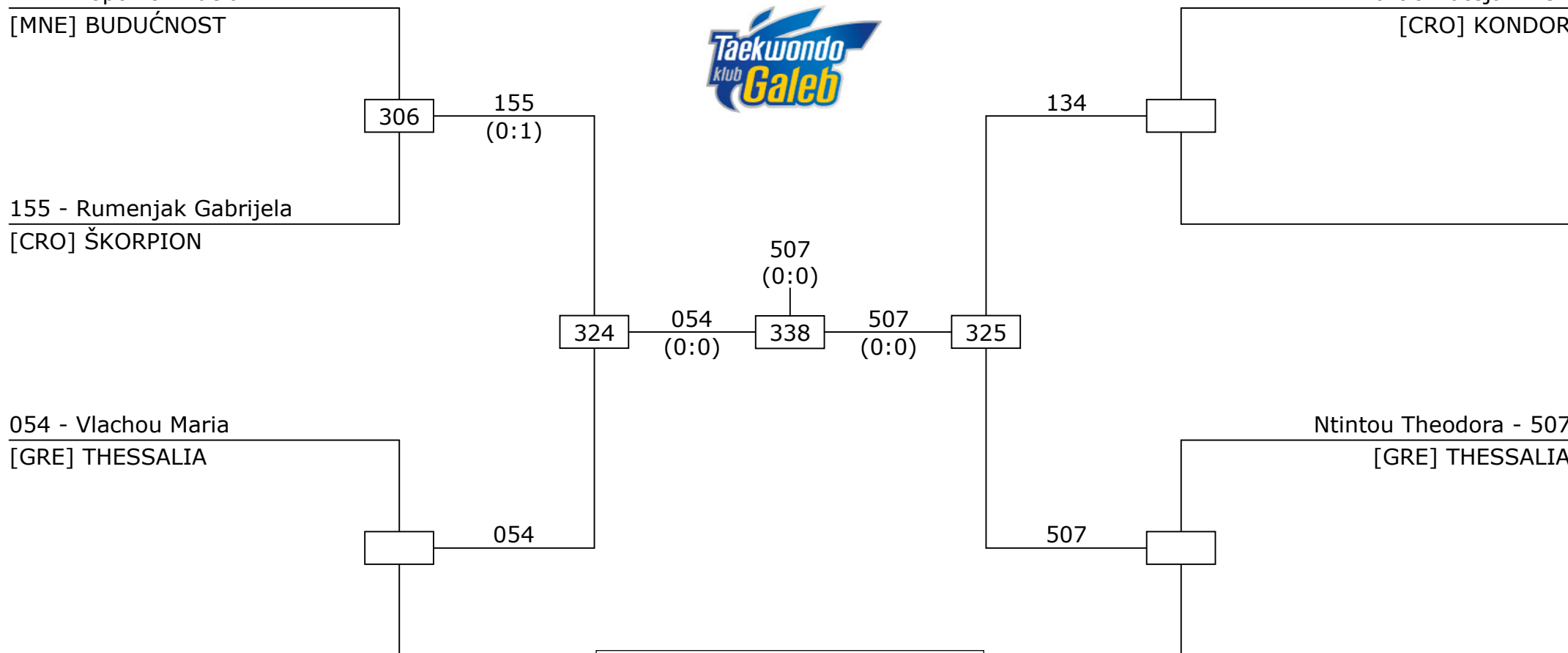

- | |
|--|
| 1. Ntintou Theodora ([GRE] THESSALIA) |
| 2. Vlachou Maria ([GRE] THESSALIA) |
| 3. Martić Mateja ([CRO] KONDOR) |
| 3. Rumenjak Gabrijela ([CRO] ŠKORPION) |

8th GALEB BELGRADE TROPHY

Competition Area 1

Cadet (A) M-33



033 - Angelov Nikolay
[BUL] FORCE SOFIA

Sekulić Slaven - 380
[BIH] SOKOL

141 - Mateo Minuš
[CRO] ORION

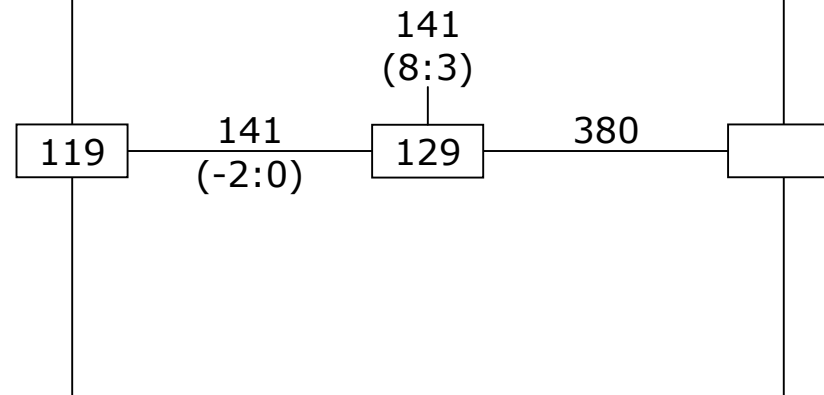

- | |
|--|
| 1. Mateo Minuš ([CRO] ORION) |
| 2. Sekulić Slaven ([BIH] SOKOL) |
| 3. Angelov Nikolay ([BUL] FORCE SOFIA) |
| 3. |

8th GALEB BELGRADE TROPHY

Competition Area 1

Cadet (A) M-37

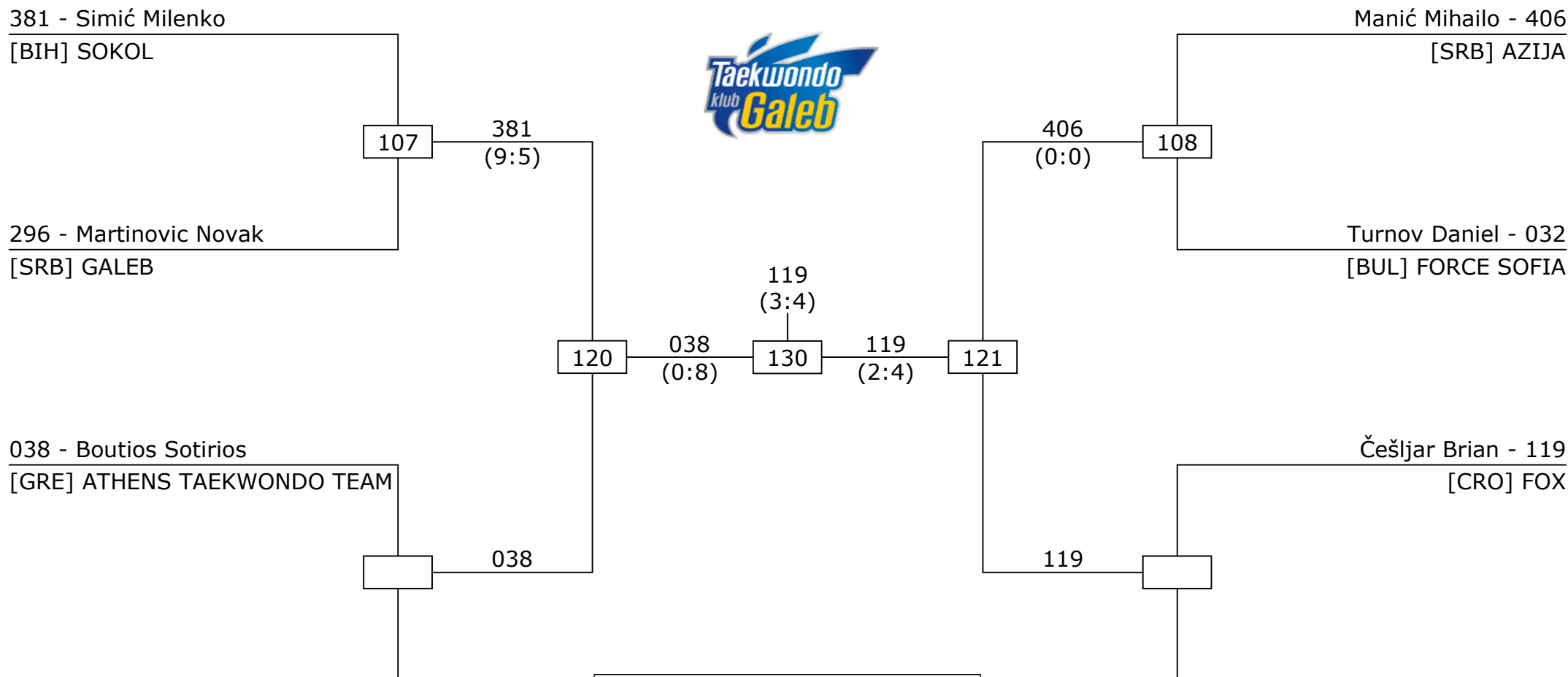

- | |
|---|
| 1. Češljarić Brian ([CRO] FOX) |
| 2. Boutios Sotirios ([GRE] ATHENS TAEKWONDO TEAM) |
| 3. Manić Mihailo ([SRB] AZIJA) |
| 3. Simić Milenko ([BIH] SOKOL) |

8th GALEB BELGRADE TROPHY

Competition Area 1

Cadet (A) M-41



097 - Biro Lukaš
[SVK] ILYO

Sibinčić Jovan - 326
[SRB] SREM

512 - Dakić Željko
[SRB] AZIJA

Šprajcar Matej - 217
[CRO] KARLOVAC

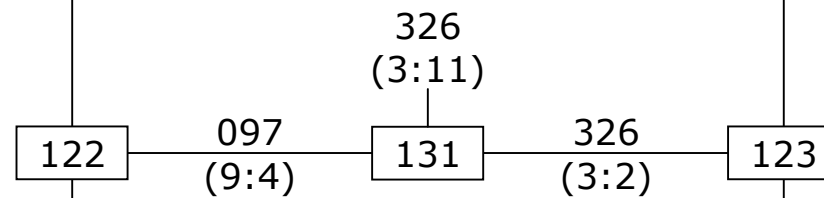

1. Sibinčić Jovan ([SRB] SREM)
2. Biro Lukaš ([SVK] ILYO)
3. Šprajcar Matej ([CRO] KARLOVAC)
3. Dakić Željko ([SRB] AZIJA)

8th GALEB BELGRADE TROPHY

Competition Area 1

Cadet (A) M-45

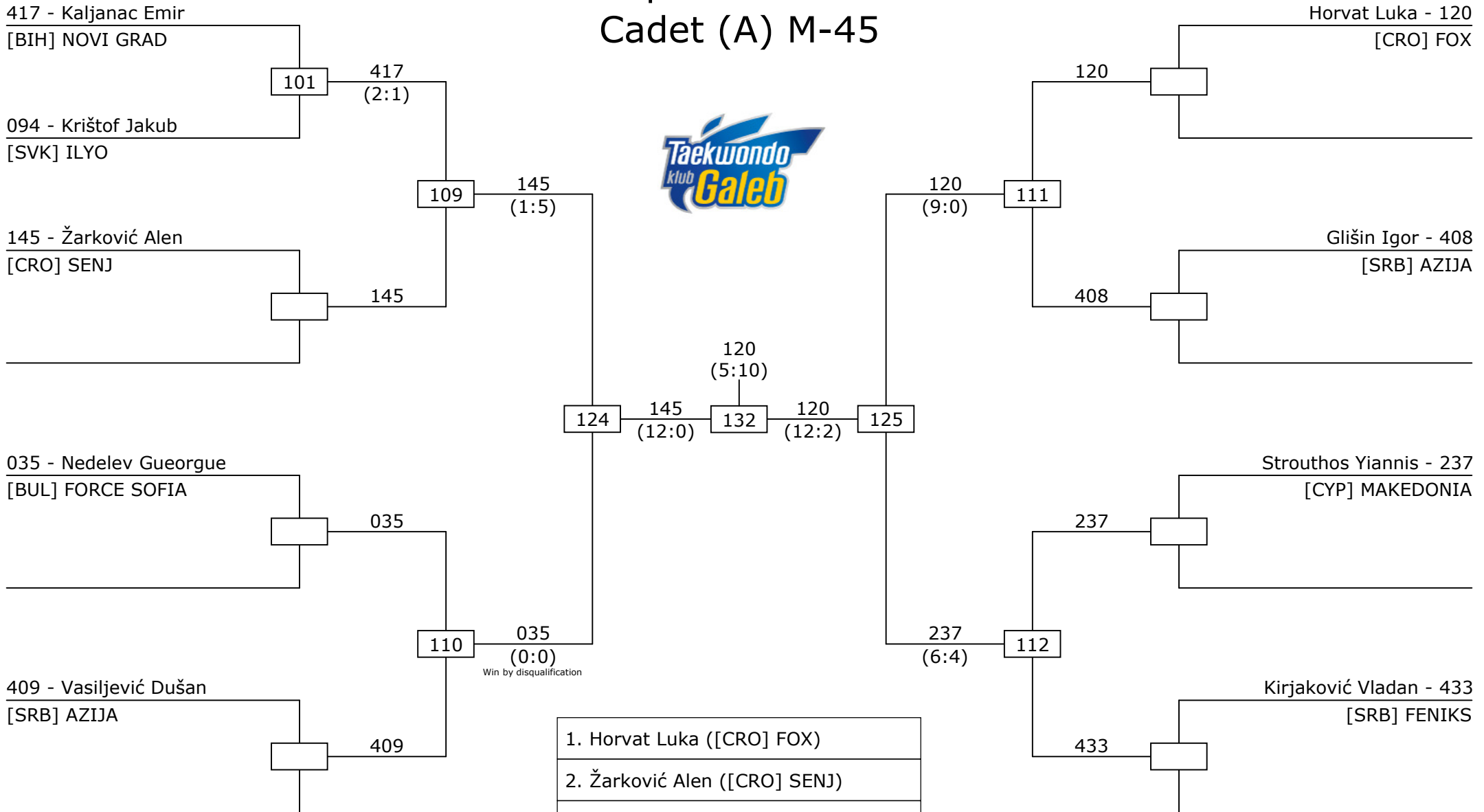

- | |
|---|
| 1. Horvat Luka ([CRO] FOX) |
| 2. Žarković Alen ([CRO] SENJ) |
| 3. Strouthos Yiannis ([CYP] MAKEDONIA) |
| 3. Nedelev Gueorgue ([BUL] FORCE SOFIA) |

8th GALEB BELGRADE TROPHY

Competition Area 2

Cadet (A) M-49



295 - Antic Filip
[SRB] GALEB

Bantanis-Kapirnas Evagelos - 056
[GRE] THESSALIA

100 - Sajko David
[SVK] ILYO

Pojar Ionut - 077
[ROU] OLIMPIC TAEKWONDO CLUB

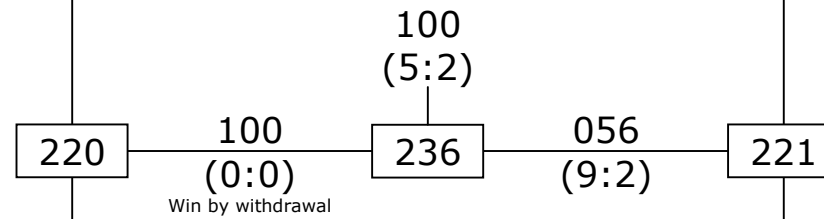

- | |
|---|
| 1. Sajko David ([SVK] ILYO) |
| 2. Bantanis-Kapirnas Evagelos ([GRE] THESSALIA) |
| 3. Pojar Ionut ([ROU] OLIMPIC TAEKWONDO CLUB) |
| 3. Antic Filip ([SRB] GALEB) |

8th GALEB BELGRADE TROPHY
Competition Area 2
Cadet (A) M-53



385 - Hidanović Jasmin [BIH] SOKOL	140 (2:5) 237	Đurđević Krešimir - 140 [CRO] METALAC
---------------------------------------	---------------------	--

1. Đurđević Krešimir ([CRO] METALAC)
2. Hidanović Jasmin ([BIH] SOKOL)
3.
3.

8th GALEB BELGRADE TROPHY

Competition Area 3

Cadet (A) M-57

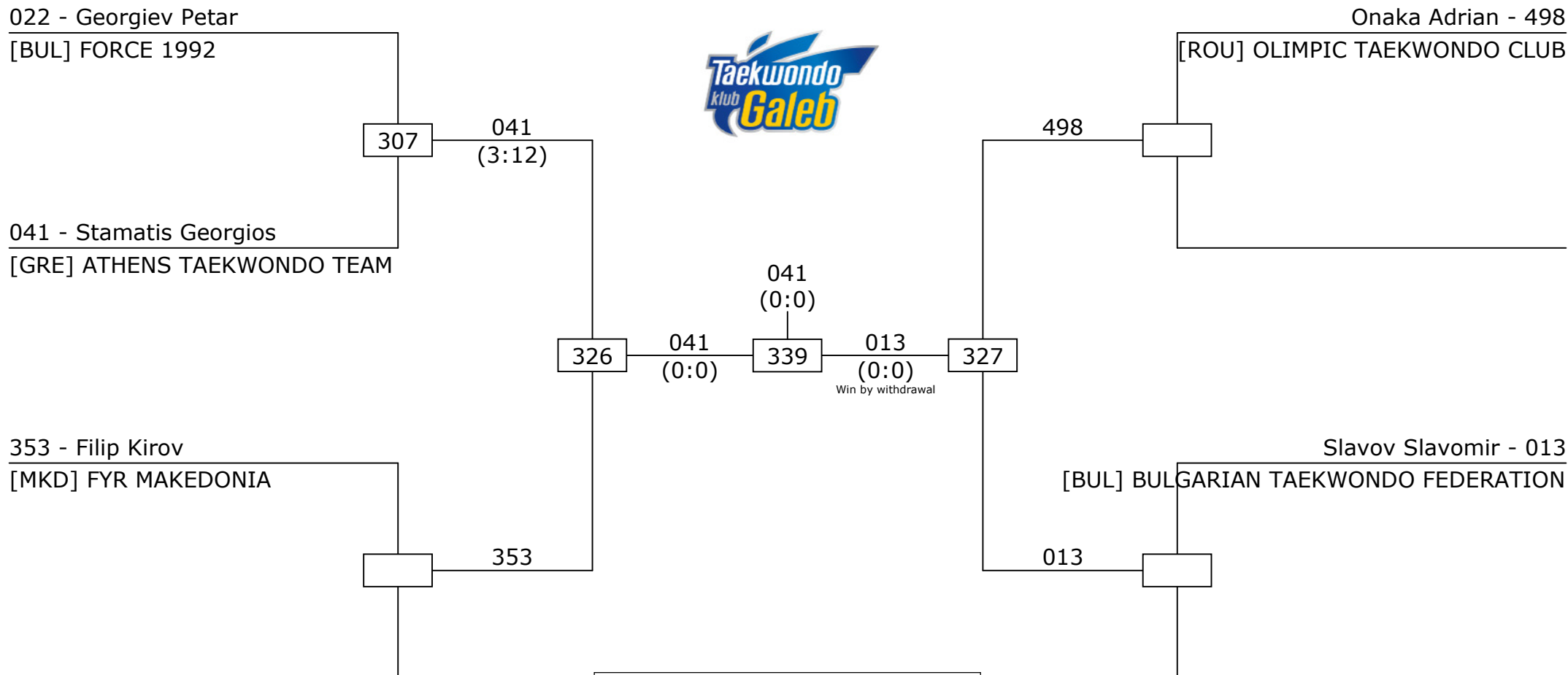

1. Stamatis Georgios ([GRE] ATHENS TAEKWONDO TEAM)
2. Slavov Slavomir ([BUL] BULGARIAN TAEKWONDO FEDERATION)
3. Onaka Adrian ([ROU] OLIMPIC TAEKWONDO CLUB)
3. Filip Kirov ([MKD] FYR MAKEDONIA)

8th GALEB BELGRADE TROPHY

Competition Area 3

Cadet (A) M-61



489 - Bradić Pavle
[SRB] FENIKS

Musesan Ionut - 076

[ROU] OLIMPIC TAEKWONDO CLUB

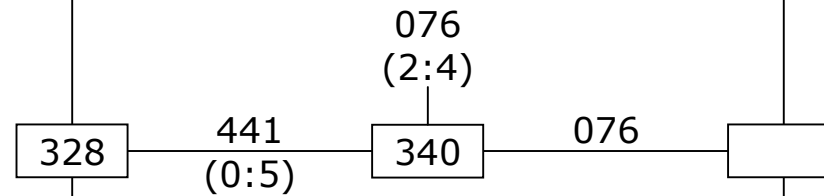

441 - Gavrilović Predrag
[SRB] GALEB

- | |
|---|
| 1. Musesan Ionut ([ROU] OLIMPIC TAEKWONDO CLUB) |
| 2. Gavrilović Predrag ([SRB] GALEB) |
| 3. Bradić Pavle ([SRB] FENIKS) |
| 3. |

8th GALEB BELGRADE TROPHY

Competition Area 3

Cadet (A) M+65



055 - Stringos Amilios
[GRE] THESSALIA

Marijančić Leon - 422
[CRO] KONDOR

442 - Briedis Aleksandar
[SRB] GALEB

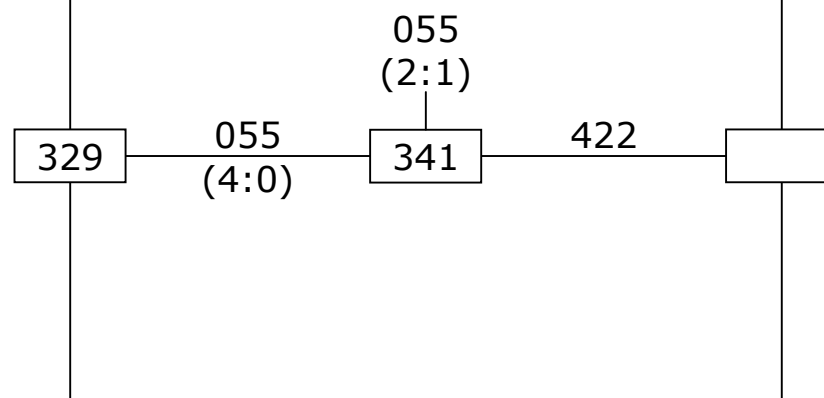

- | |
|---------------------------------------|
| 1. Stringos Amilios ([GRE] THESSALIA) |
| 2. Marijančić Leon ([CRO] KONDOR) |
| 3. Briedis Aleksandar ([SRB] GALEB) |
| 3. |

8th GALEB BELGRADE TROPHY

Competition Area 2

Junior F-46



458 - Vukolić Milica
[SRB] OMEGA

009 - Borisova Borisa
[BUL] BULGARIAN TAEKWONDO FEDERATION

066 - Goltsiou Stamatia
[GRE] THESSALIA

Antoaneta Nikolaeva Noteva - 376
[BUL] TANGRA

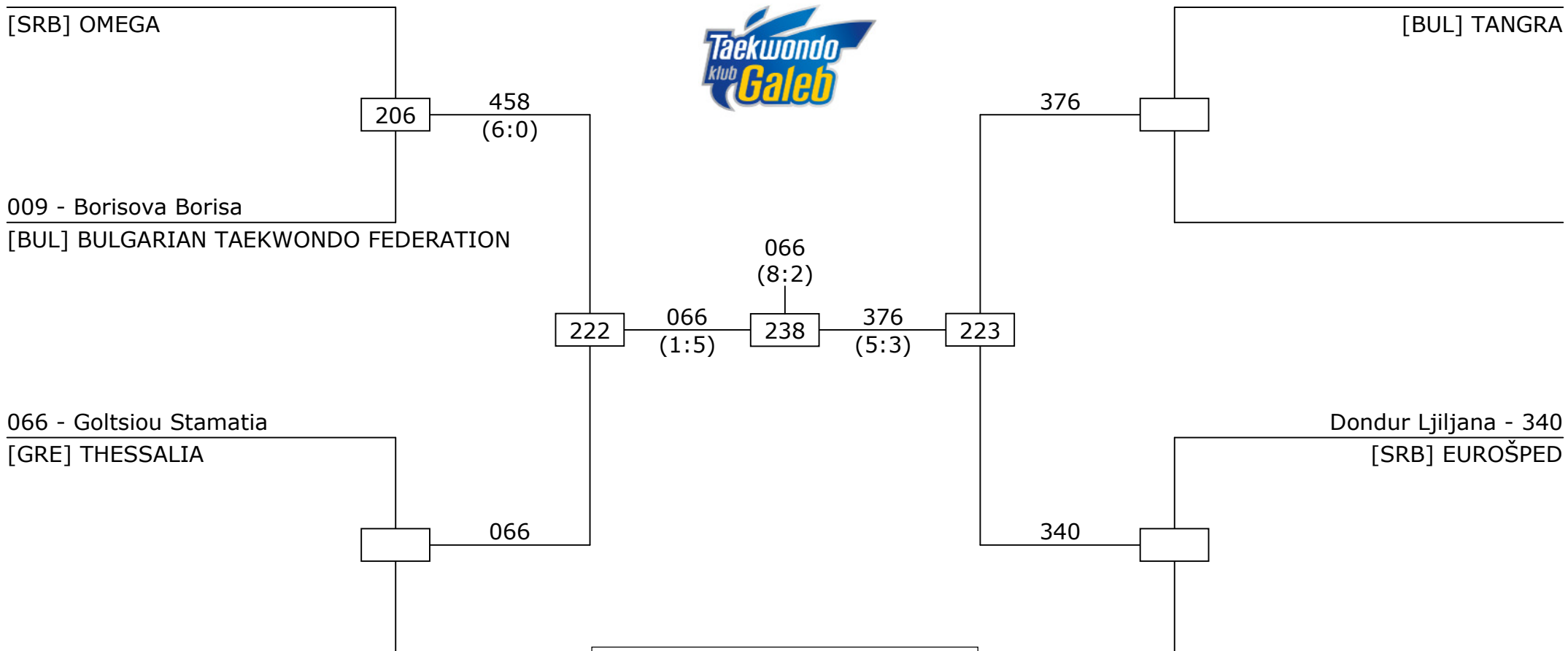

- | |
|--|
| 1. Goltsiou Stamatia ([GRE] THESSALIA) |
| 2. Antoaneta Nikolaeva Noteva ([BUL] TANGRA) |
| 3. Dondur Ljiljana ([SRB] EUROŠPED) |
| 3. Vukolić Milica ([SRB] OMEGA) |

8th GALEB BELGRADE TROPHY

Competition Area 2

Junior F-49



324 - Lukić Đurđija
[SRB] VINER ČIVI

Papcunova Zuzana - 099
[SVK] ILYO

065 - Goltsiou Ioanna
[GRE] THESSALIA

Silvija Stojanovska - 363
[MKD] FYR MAKEDONIA

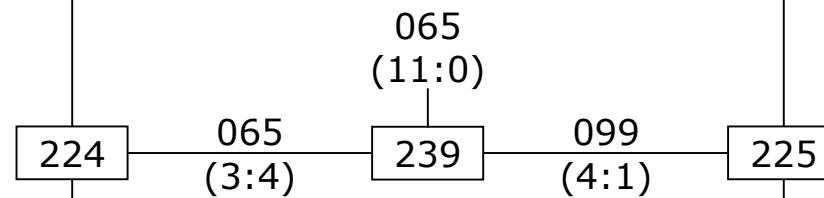

- | |
|--|
| 1. Goltsiou Ioanna ([GRE] THESSALIA) |
| 2. Papcunova Zuzana ([SVK] ILYO) |
| 3. Silvija Stojanovska ([MKD] FYR MAKEDONIA) |
| 3. Lukić Đurđija ([SRB] VINER ČIVI) |

8th GALEB BELGRADE TROPHY

Competition Area 2

Junior F-52

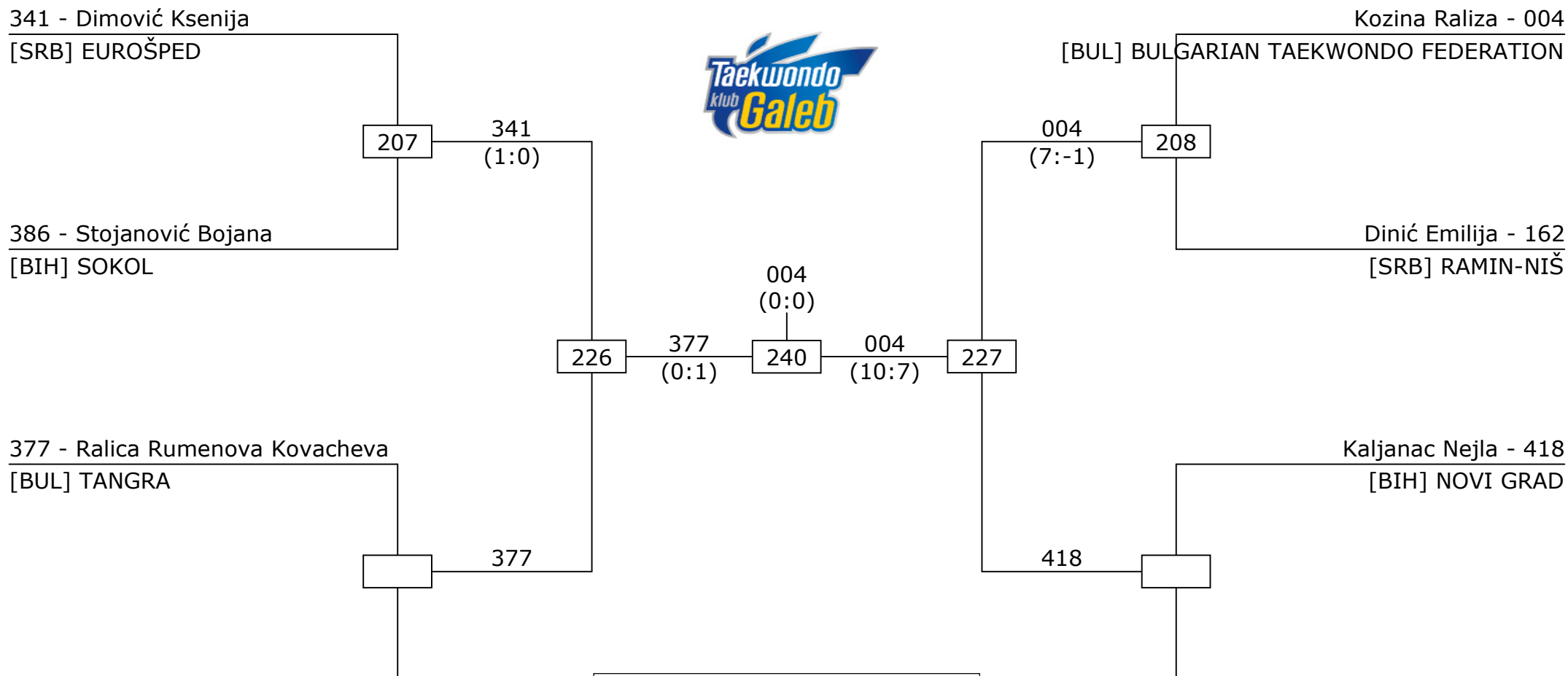

- | |
|---|
| 1. Kozina Raliza ([BUL] BULGARIAN TAEKWONDO FEDERATION) |
| 2. Ralica Rumenova Kovacheva ([BUL] TANGRA) |
| 3. Kaljanac Nejla ([BIH] NOVI GRAD) |
| 3. Dimović Ksenija ([SRB] EUROŠPED) |

8th GALEB BELGRADE TROPHY

Competition Area 2

Junior F-55

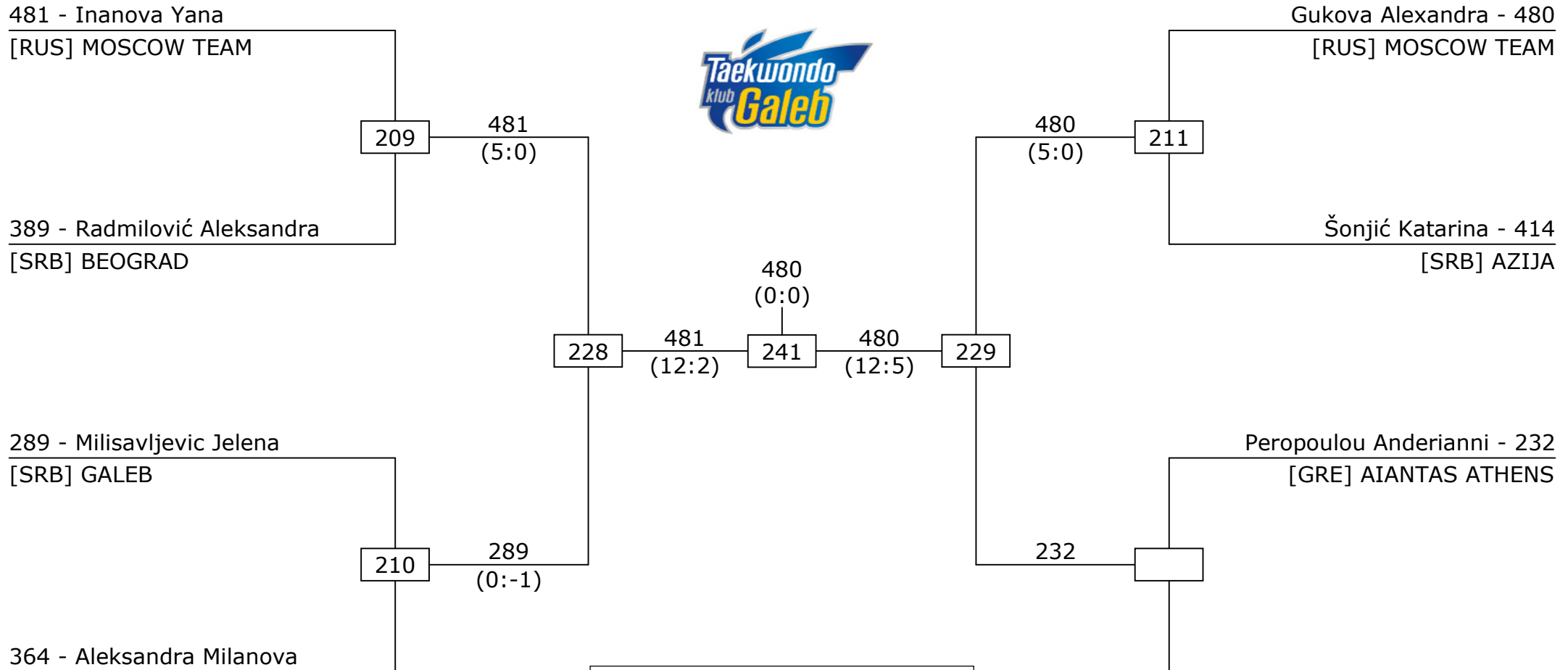

- | |
|---|
| 1. Gukova Alexandra ([RUS] MOSCOW TEAM) |
| 2. Inanova Yana ([RUS] MOSCOW TEAM) |
| 3. Peropoulou Anderianni ([GRE] AIANTAS ATHENS) |
| 3. Milisavljevic Jelena ([SRB] GALEB) |

8th GALEB BELGRADE TROPHY

Competition Area 3

Junior F-59

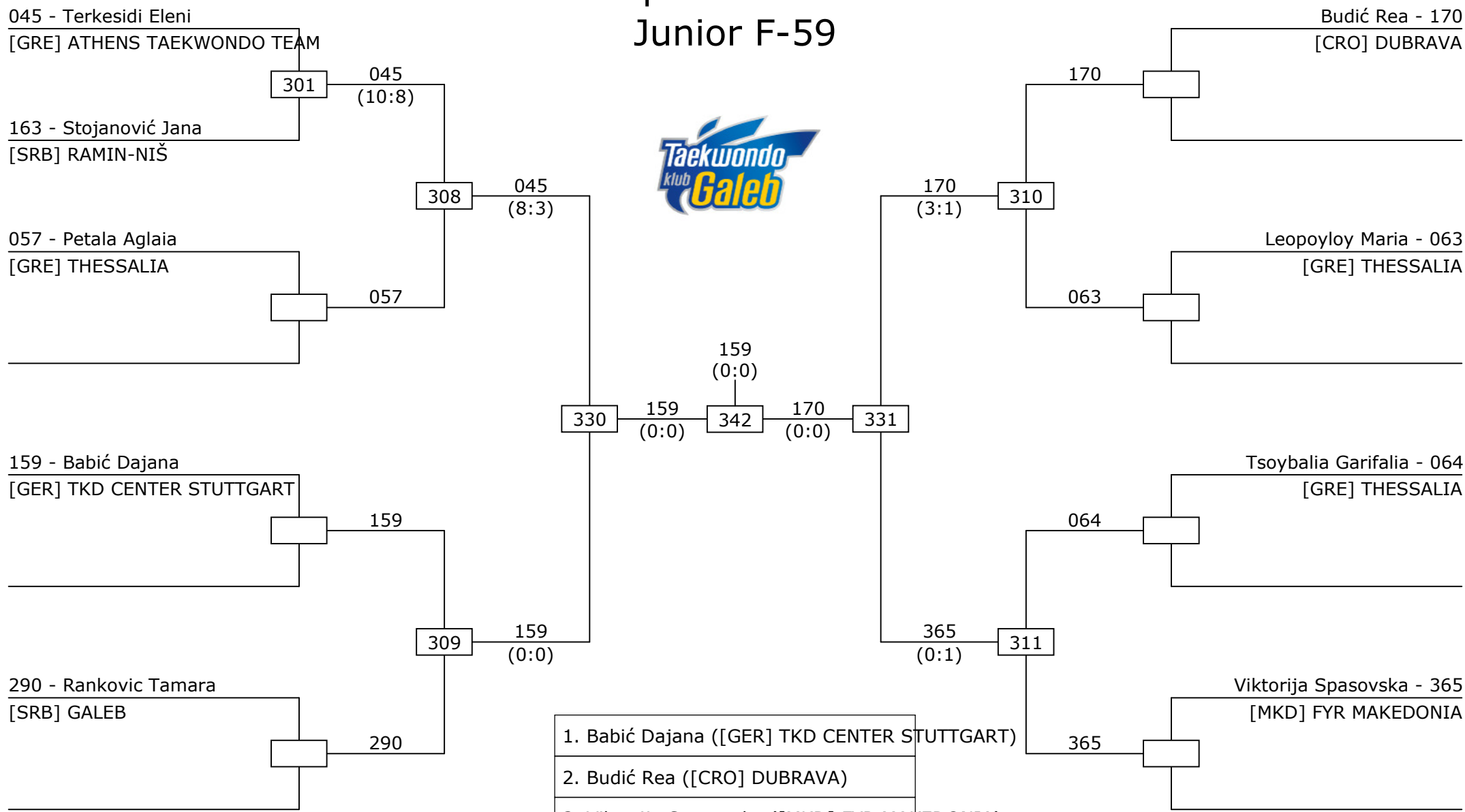

- | |
|--|
| 1. Babić Dajana ([GER] TKD CENTER STUTT GART) |
| 2. Budić Rea ([CRO] DUBRAVA) |
| 3. Viktorija Spasovska ([MKD] FYR MAKEDONIA) |
| 3. Terkesidi Eleni ([GRE] ATHENS TAEKWONDO TEAM) |

8th GALEB BELGRADE TROPHY

Competition Area 2

Junior M-48



060 - Orfanidis Anastasios
[GRE] THESSALIA

Rezo Bruno - 174
[CRO] DUBRAVA

241 - Matanović Bojan
[MNE] MONTENEGRO STARS

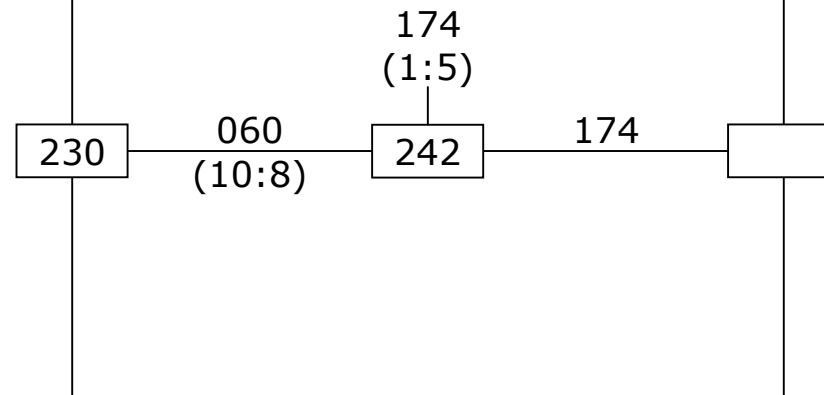

1. Rezo Bruno ([CRO] DUBRAVA)
2. Orfanidis Anastasios ([GRE] THESSALIA)
3. Matanović Bojan ([MNE] MONTENEGRO STARS)
3.

8th GALEB BELGRADE TROPHY

Competition Area 2

Junior M-55

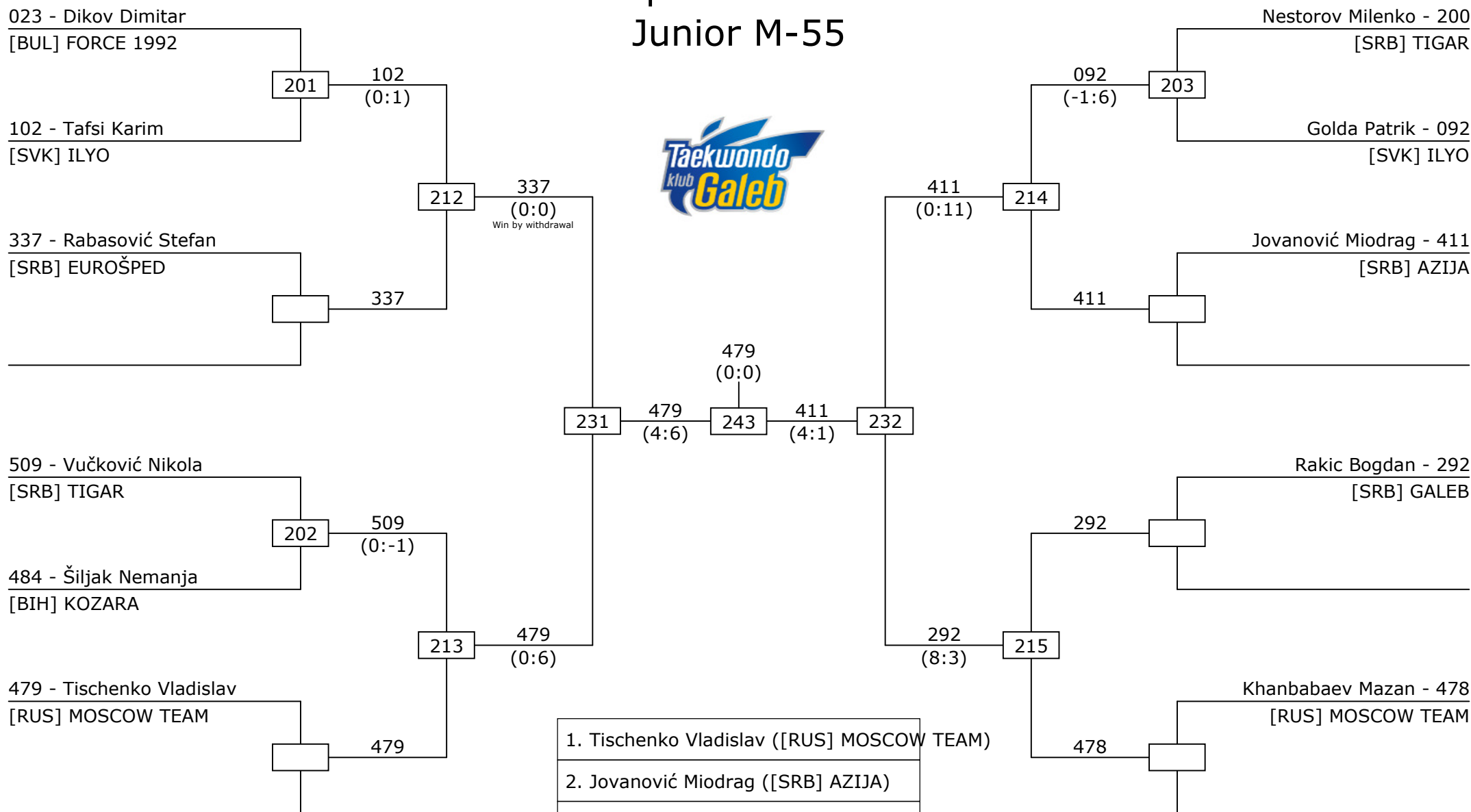

8th GALEB BELGRADE TROPHY

Competition Area 3

Junior M-59

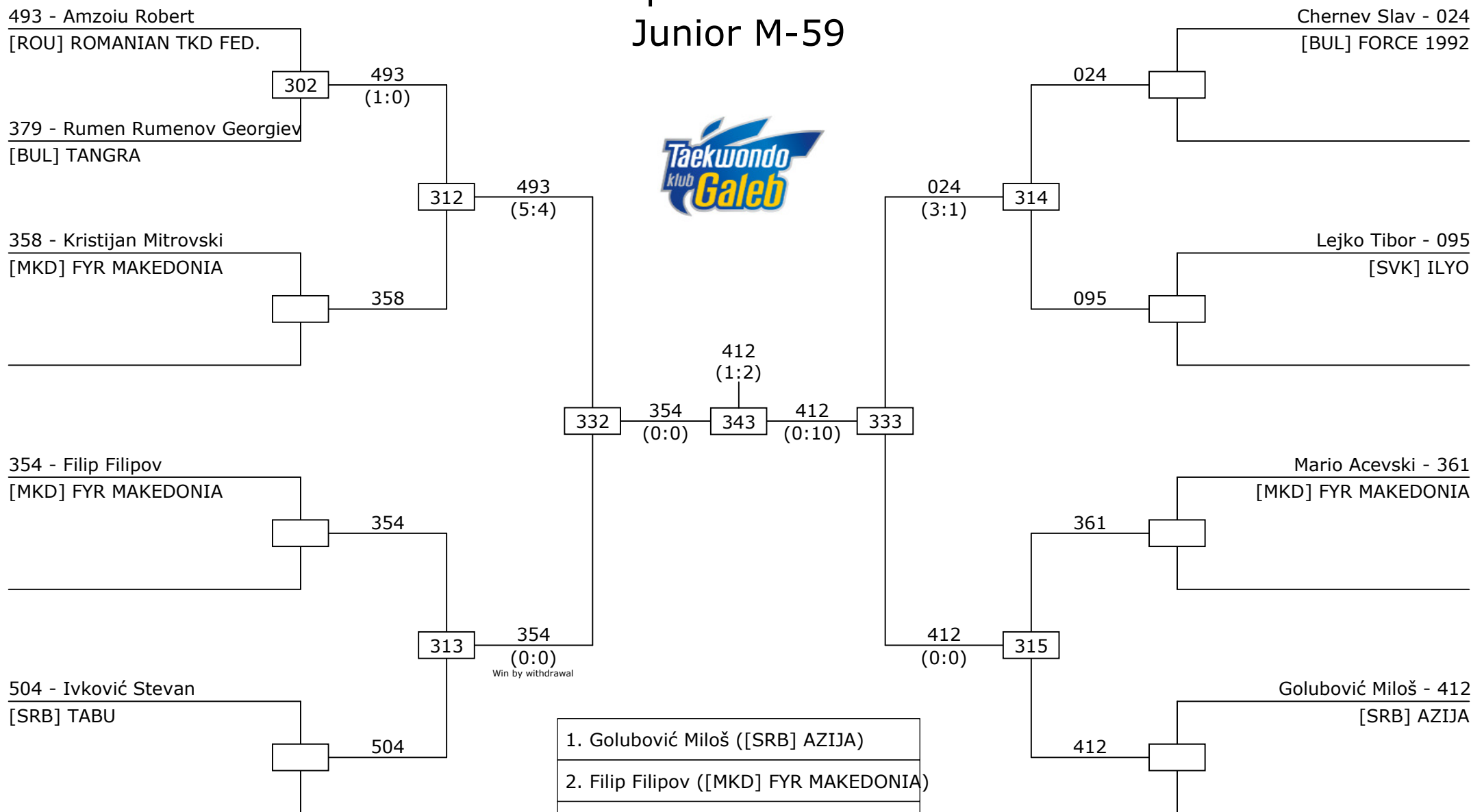

- | |
|--|
| 1. Golubović Miloš ([SRB] AZIJA) |
| 2. Filip Filipov ([MKD] FYR MAKEDONIA) |
| 3. Chernev Slav ([BUL] FORCE 1992) |
| 3. Amzoiu Robert ([ROU] ROMANIAN TKD FED.) |

8th GALEB BELGRADE TROPHY

Competition Area 3

Junior M-63

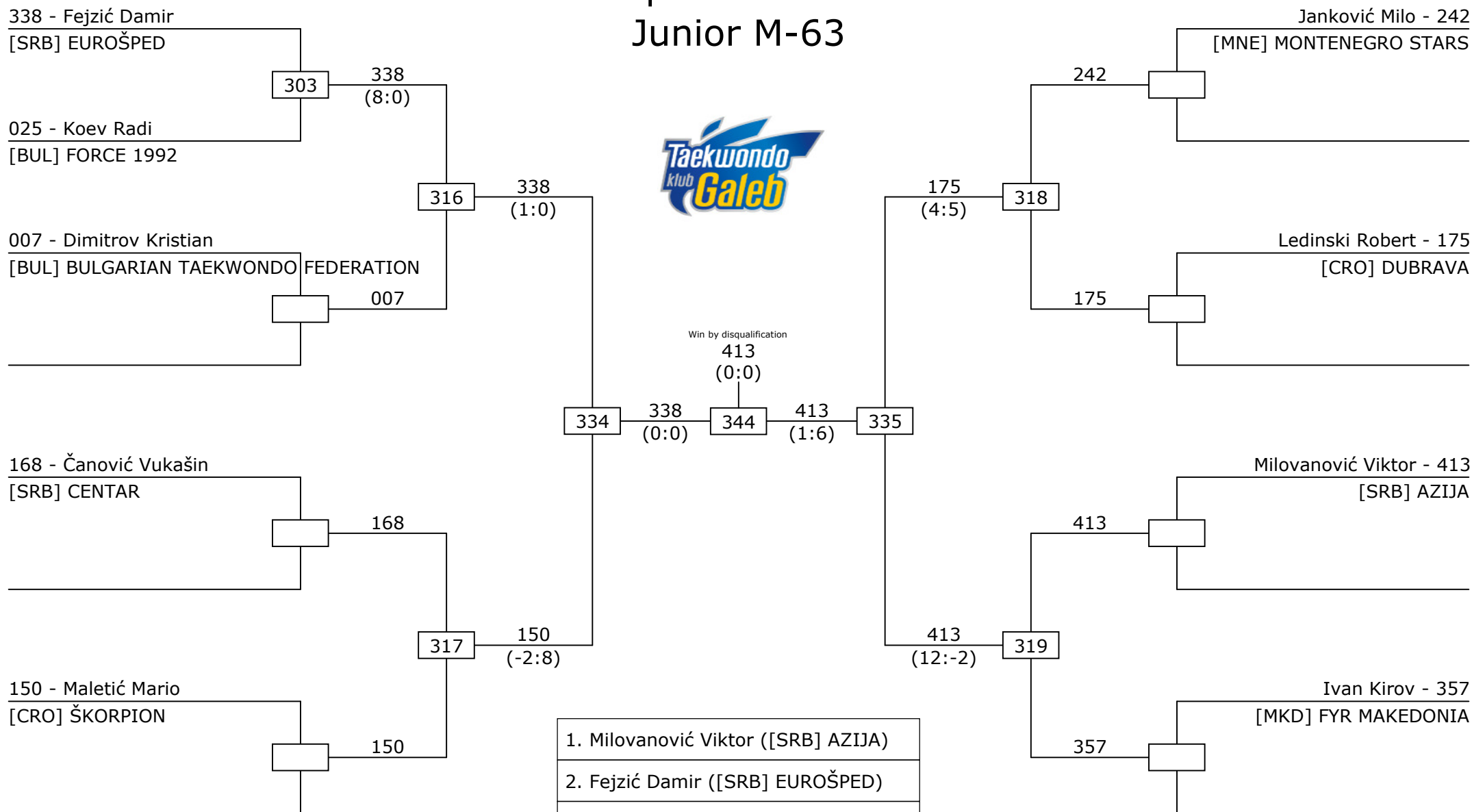

- | |
|-------------------------------------|
| 1. Milovanović Viktor ([SRB] AZIJA) |
| 2. Fejzić Damir ([SRB] EUROŠPED) |
| 3. Ledinski Robert ([CRO] DUBRAVA) |
| 3. Maletić Mario ([CRO] ŠKORPION) |

8th GALEB BELGRADE TROPHY

Competition Area 3

Junior M-68

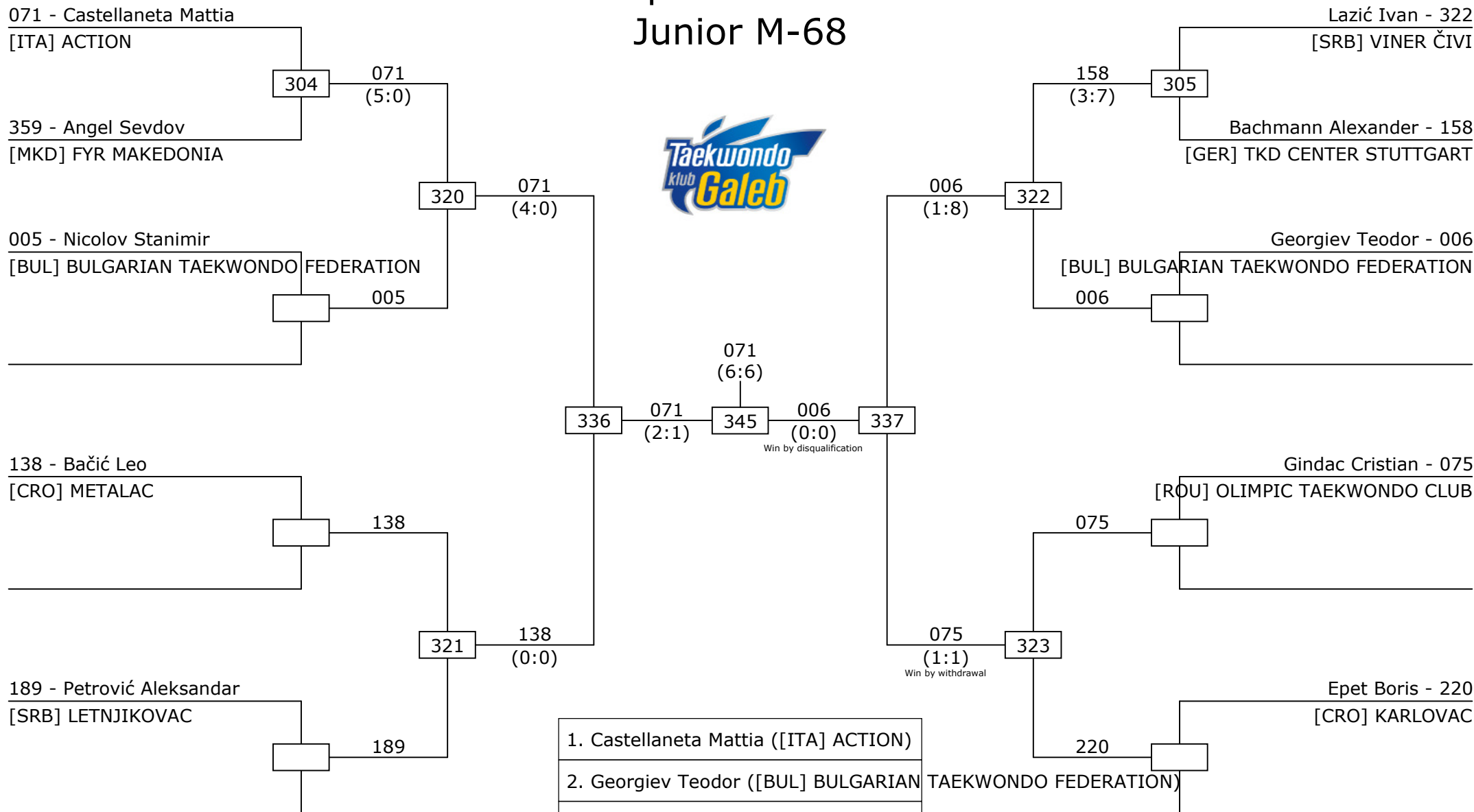

- | |
|---|
| 1. Castellaneta Mattia ([ITA] ACTION) |
| 2. Georgiev Teodor ([BUL] BULGARIAN TAEKWONDO FEDERATION) |
| 3. Gindac Cristian ([ROU] OLIMPIC TAEKWONDO CLUB) |
| 3. Bačić Leo ([CRO] METALAC) |

8th GALEB BELGRADE TROPHY

Competition Area 2

Junior F-63



047 - Polihroni Evangelia
[GRE] ATHENS TAEKWONDO TEAM

482 - Milinović Gorana
[BIH] KOZARA

512 - Popović Anđela
[MNE] BUDUĆNOST

Ntintou Theodora - 067
[GRE] THESSALIA

Ilić Milica - 186
[SRB] LETNJKOVAC

Perišić Dajana - 342
[SRB] EUROŠPED

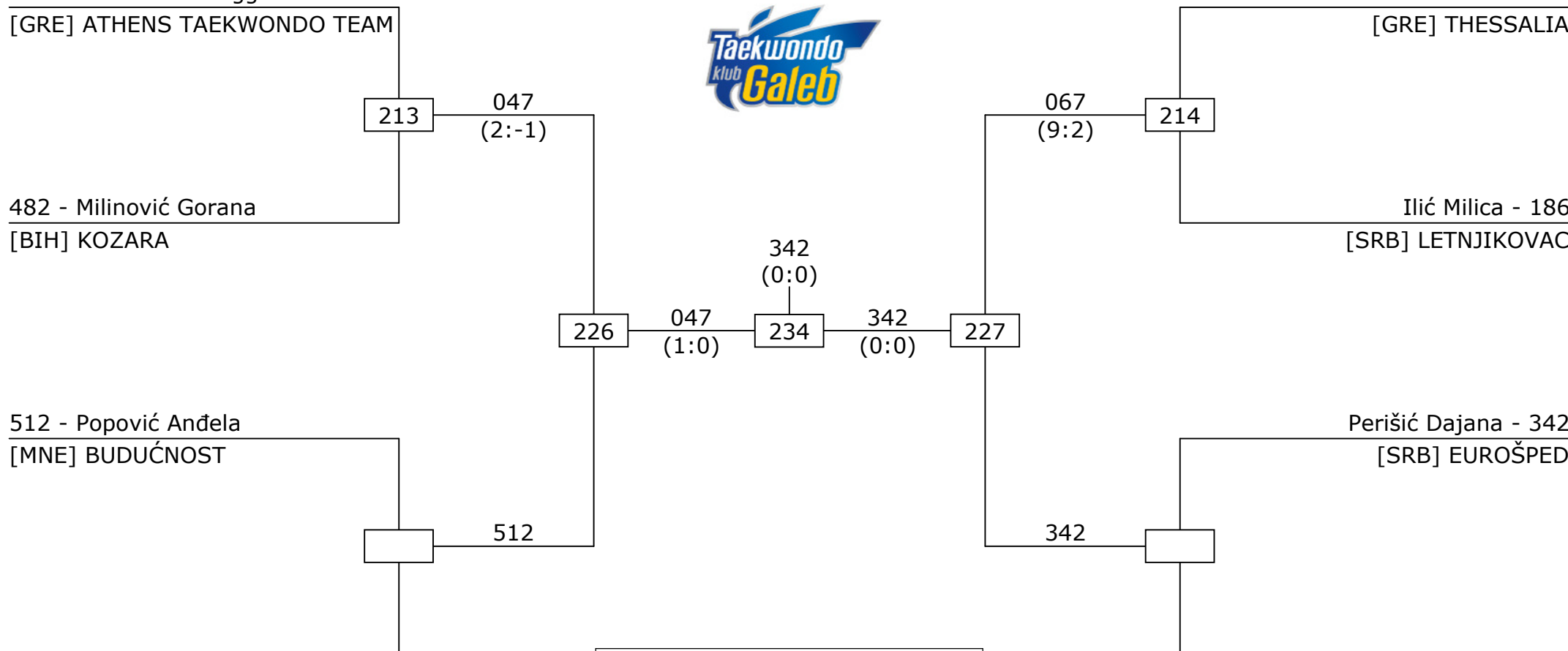

- | |
|--|
| 1. Perišić Dajana ([SRB] EUROŠPED) |
| 2. Polihroni Evangelia ([GRE] ATHENS TAEKWONDO TEAM) |
| 3. Ntintou Theodora ([GRE] THESSALIA) |
| 3. Popović Anđela ([MNE] BUDUĆNOST) |

8th GALEB BELGRADE TROPHY

Competition Area 3

Junior F-68

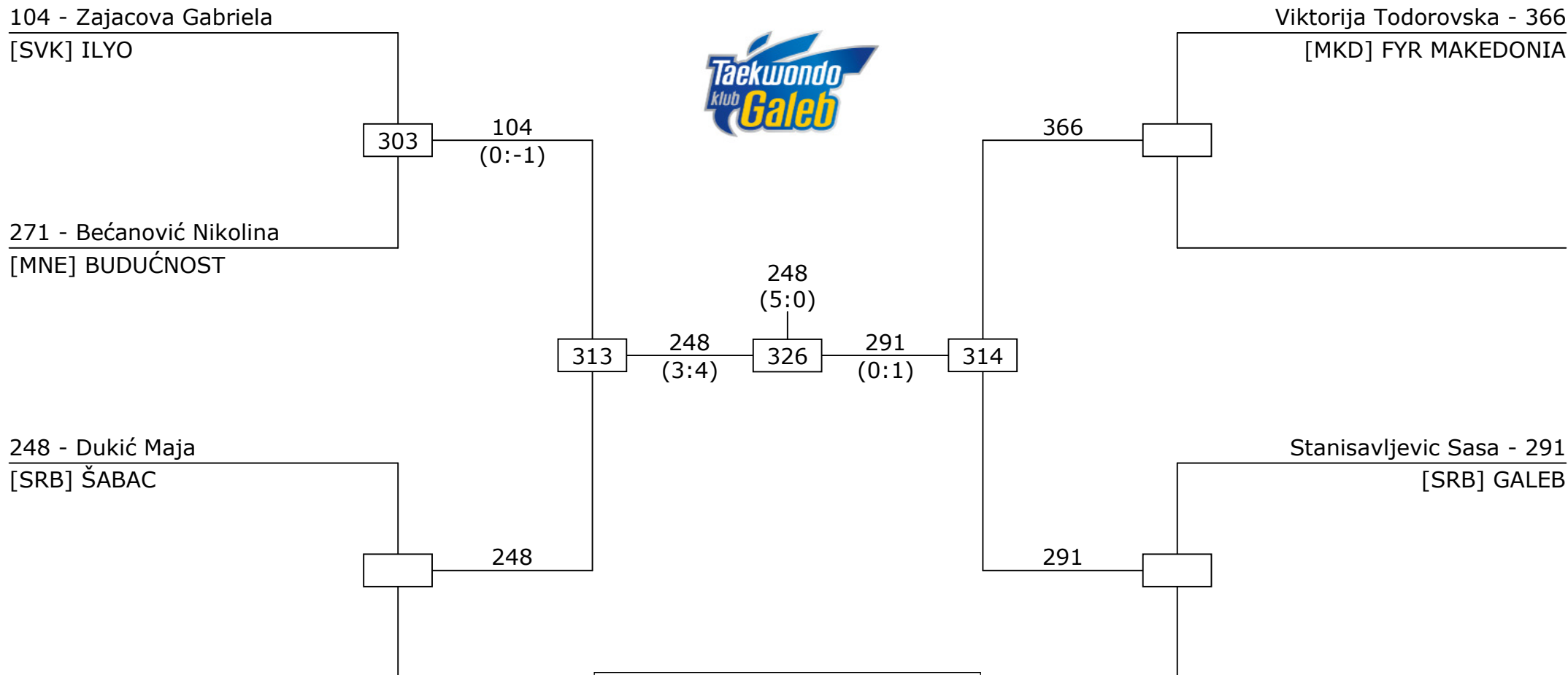

- | |
|---|
| 1. Dukić Maja ([SRB] ŠABAC) |
| 2. Stanisavljevic Sasa ([SRB] GALEB) |
| 3. Viktorija Todorovska ([MKD] FYR MAKEDONIA) |
| 3. Zajacova Gabriela ([SVK] ILYO) |

8th GALEB BELGRADE TROPHY

Competition Area 3

Junior F+68



369 - Živković Tihana
[CRO] ZAPREŠČIĆ

Bajić Ana - 394
[SRB] ELIT

171 - Radoš Mia
[CRO] DUBRAVA

Bojana Pesevska - 367
[MKD] FYR MAKEDONIA

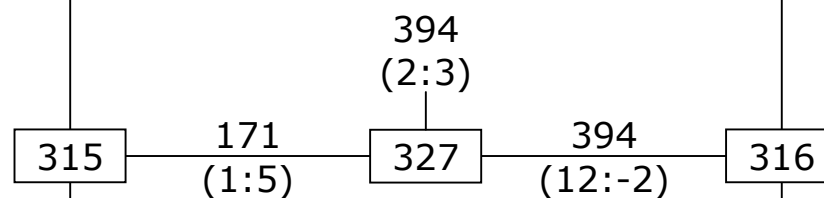

- | |
|--|
| 1. Bajić Ana ([SRB] ELIT) |
| 2. Radoš Mia ([CRO] DUBRAVA) |
| 3. Bojana Pesevska ([MKD] FYR MAKEDONIA) |
| 3. Živković Tihana ([CRO] ZAPREŠČIĆ) |

8th GALEB BELGRADE TROPHY

Competition Area 3

Junior M-73

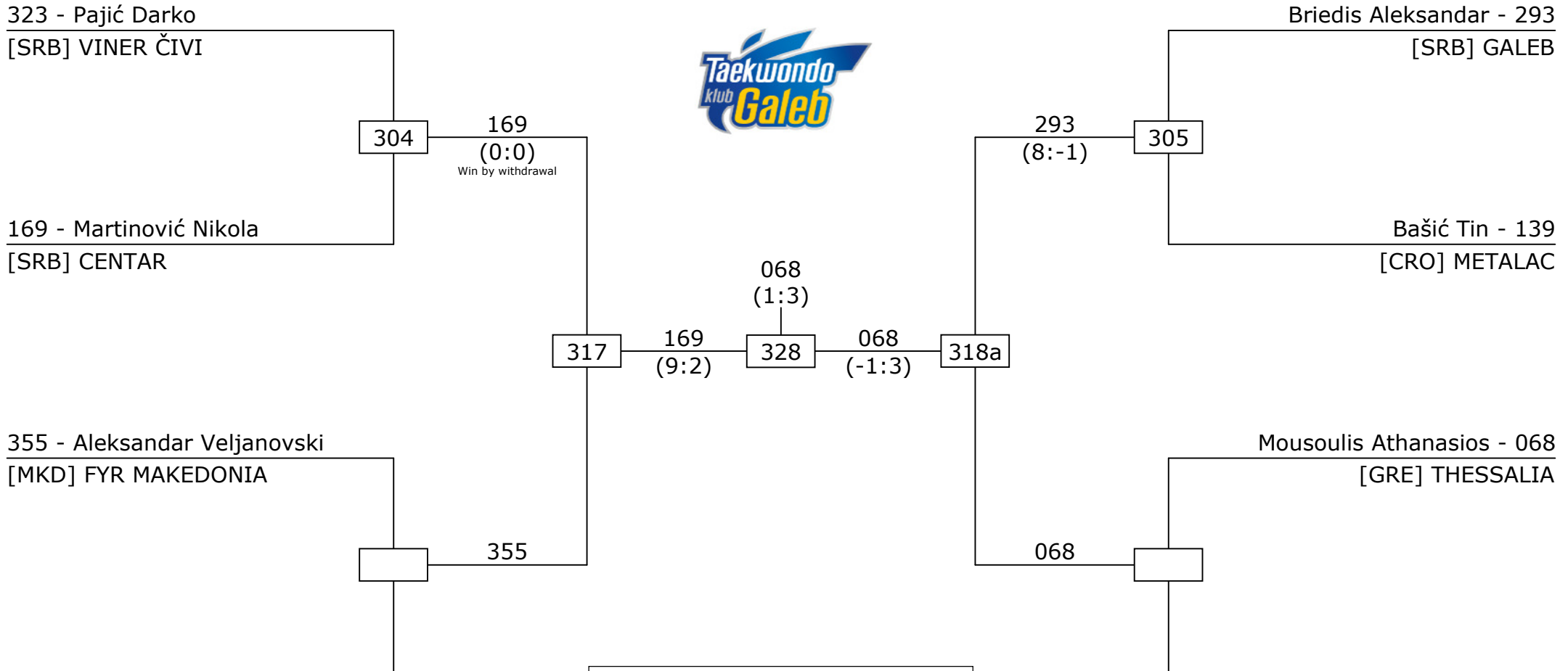

- | |
|---|
| 1. Mousoulis Athanasios ([GRE] THESSALIA) |
| 2. Martinović Nikola ([SRB] CENTAR) |
| 3. Briedis Aleksandar ([SRB] GALEB) |
| 3. Aleksandar Veljanovski ([MKD] FYR MAKEDONIA) |

8th GALEB BELGRADE TROPHY

Competition Area 3

Junior M-78



339 - Rabijac Stojan
[SRB] EUROŠPED

Bilić Vedran - 373
[CRO] ZAPREŠČIĆ

517 - Vaduva Cosmin
[ROU] OLIMPIC TAEKWONDO CLUB

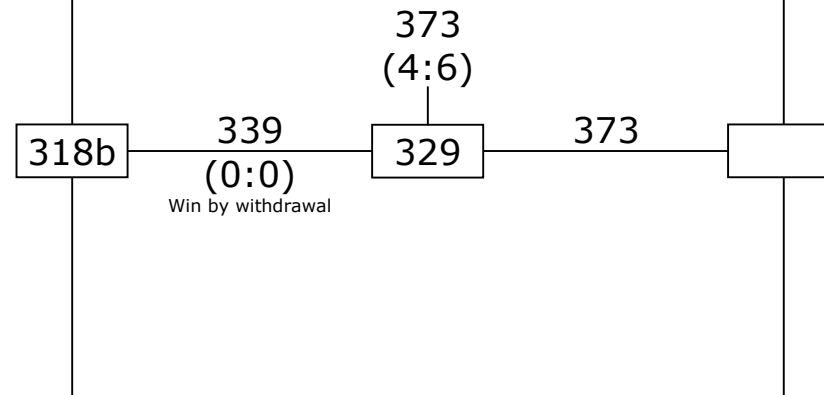

- | |
|---|
| 1. Bilić Vedran ([CRO] ZAPREŠČIĆ) |
| 2. Rabijac Stojan ([SRB] EUROŠPED) |
| 3. Vaduva Cosmin ([ROU] OLIMPIC TAEKWONDO CLUB) |
| 3. |

8th GALEB BELGRADE TROPHY

Competition Area 1

Junior M+78



360 - Dennis Kralevski
[MKD] FYR MAKEDONIA

Jane Stojcevski - 356
[MKD] FYR MAKEDONIA

221 - Muhić Marko
[CRO] KARLOVAC

Jandrić Nikola - 432
[SRB] FENIKS

370 - Šamec Ivan
[CRO] ZAPREŠČIĆ

Vojnović Miloš - 459
[SRB] OMEGA

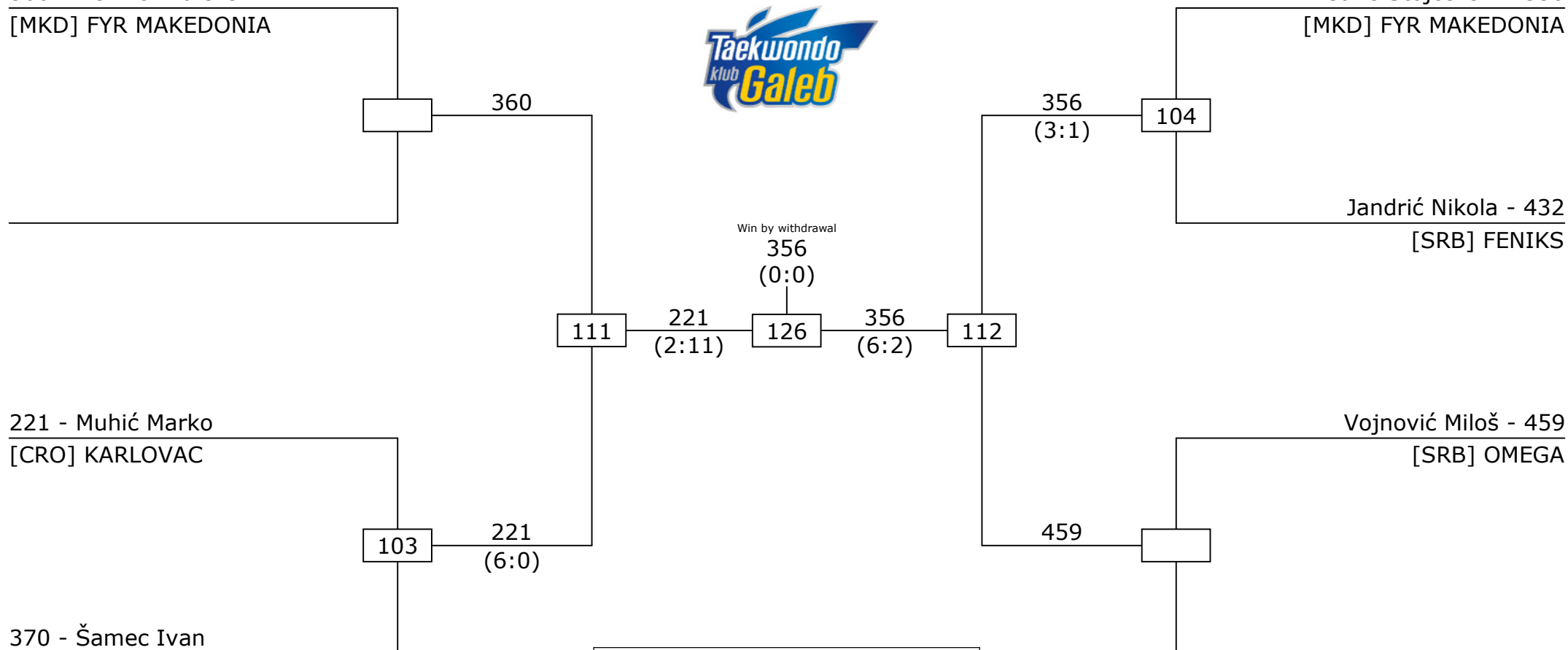

- | |
|---|
| 1. Jane Stojcevski ([MKD] FYR MAKEDONIA) |
| 2. Muhić Marko ([CRO] KARLOVAC) |
| 3. Vojnović Miloš ([SRB] OMEGA) |
| 3. Dennis Kralevski ([MKD] FYR MAKEDONIA) |

8th GALEB BELGRADE TROPHY

Competition Area 1

Senior F-46



514 - Goltsiou Ioanna
[GRE] THESSALIA

Popova Lubomira - 037
[BUL] FORCE SOFIA

511 - Dondur Ljiljana
[SRB] EUROŠPED

Eneva Iliana - 516
[BUL] TANGRA

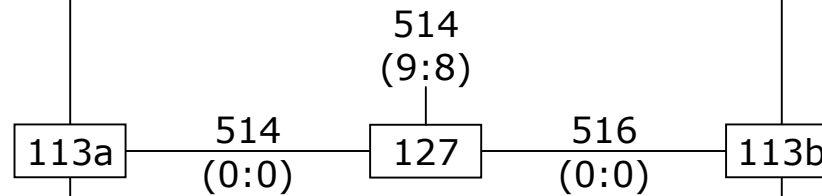

- | |
|--|
| 1. Goltsiou Ioanna ([GRE] THESSALIA) |
| 2. Eneva Iliana ([BUL] TANGRA) |
| 3. Popova Lubomira ([BUL] FORCE SOFIA) |
| 3. Dondur Ljiljana ([SRB] EUROŠPED) |

8th GALEB BELGRADE TROPHY

Competition Area 1

Senior F-53



003 - Kozina Raliza

[BUL] BULGARIAN TAEKWONDO FEDERATION

Vrabec Monika - 368

[CRO] ZAPREŠČIĆ

240 - Lucaciu Anaharia

[ITA] CITTA DEL PIAVE

Stefanova Tania - 026

[BUL] FORCE 1992

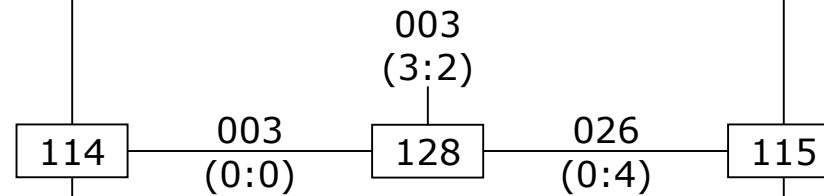

- | |
|---|
| 1. Kozina Raliza ([BUL] BULGARIAN TAEKWONDO FEDERATION) |
| 2. Stefanova Tania ([BUL] FORCE 1992) |
| 3. Vrabec Monika ([CRO] ZAPREŠČIĆ) |
| 3. Lucaciu Anaharia ([ITA] CITTA DEL PIAVE) |

8th GALEB BELGRADE TROPHY

Competition Area 1

Senior F-57

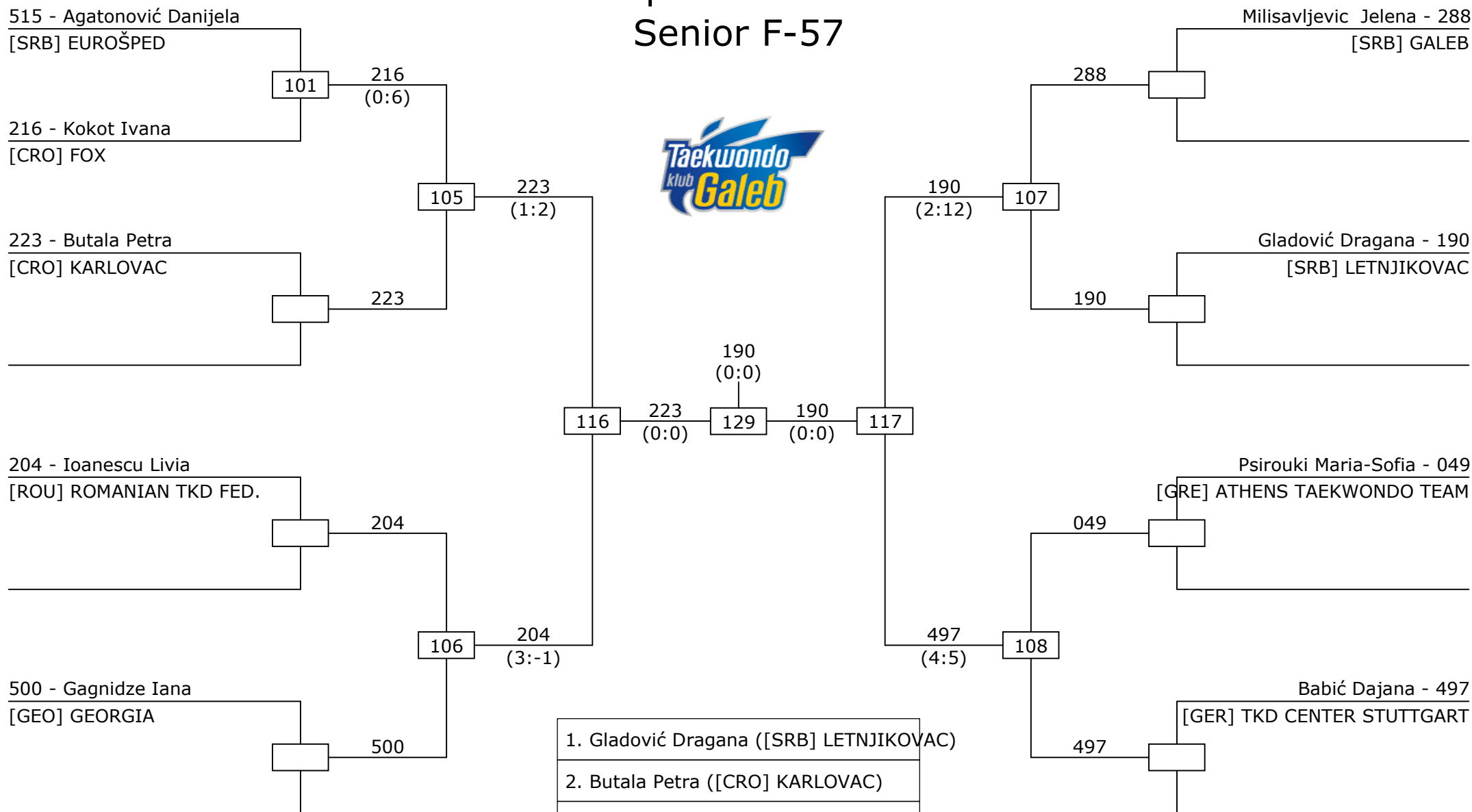

- | |
|--|
| 1. Gladović Dragana ([SRB] LETNJIKOVAC) |
| 2. Butala Petra ([CRO] KARLOVAC) |
| 3. Babić Dajana ([GER] TKD CENTER STUTTGART) |
| 3. Ioanescu Livia ([ROU] ROMANIAN TKD FED.) |

8th GALEB BELGRADE TROPHY

Competition Area 2

Senior F-62

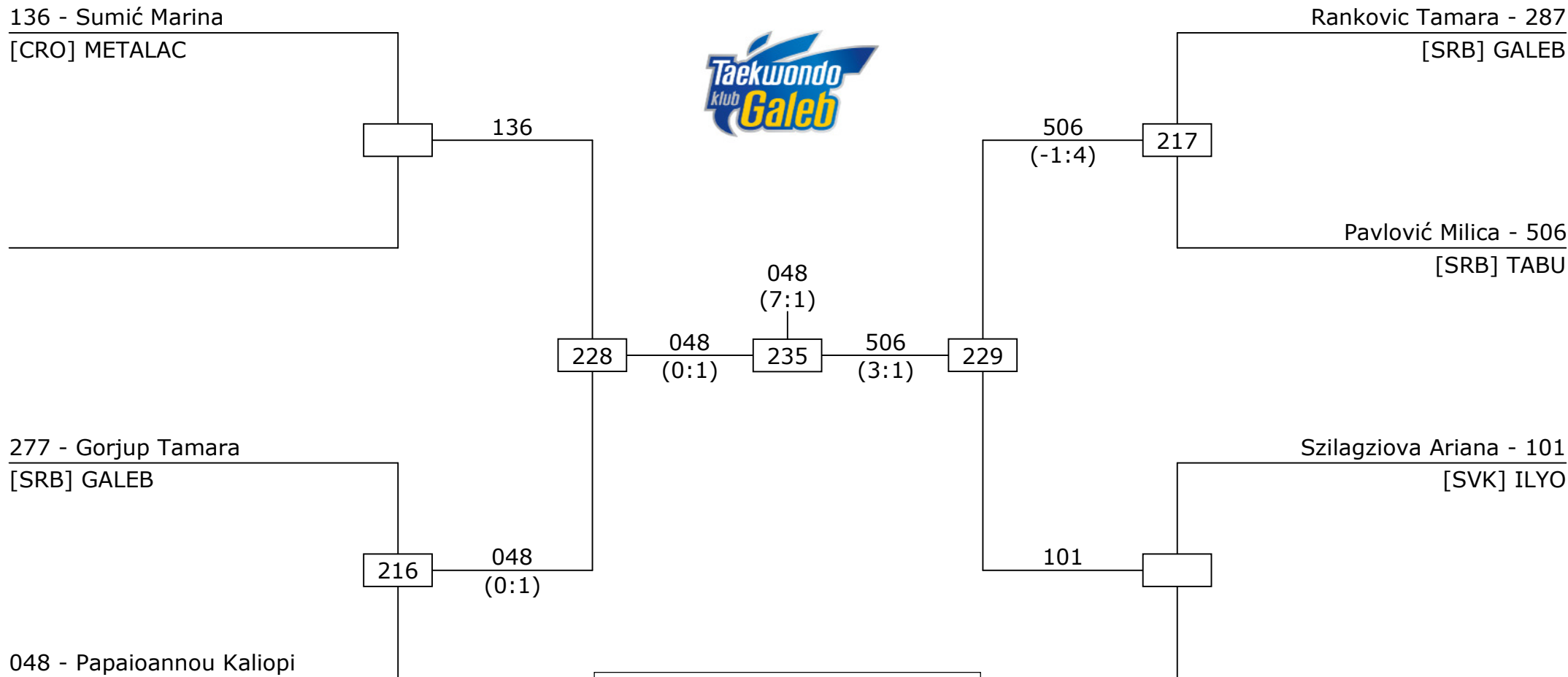

- | |
|--|
| 1. Papaioannou Kaliopi ([GRE] ATHENS TAEKWONDO TEAM) |
| 2. Pavlović Milica ([SRB] TABU) |
| 3. Szilagziova Ariana ([SVK] ILYO) |
| 3. Sumić Marina ([CRO] METALAC) |

8th GALEB BELGRADE TROPHY

Competition Area 3

Senior F-67



172 - Radić Anamarija
[CRO] DUBRAVA

Milenković Tijana - 164
[SRB] RAMIN-NIŠ

392 - Filipović Svetlana
[SRB] BEOGRAD

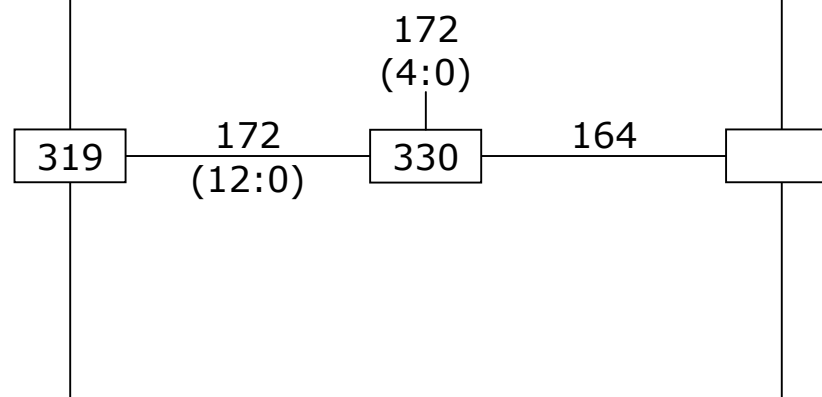

1. Radić Anamarija ([CRO] DUBRAVA)
2. Milenković Tijana ([SRB] RAMIN-NIŠ)
3. Filipović Svetlana ([SRB] BEOGRAD)
3.

8th GALEB BELGRADE TROPHY

Competition Area 3

Senior F+73



464 - Munćan Dragica
[SRB] VRŠAC

Jazbec Martina - 173
[CRO] DUBRAVA

147 - Lopac Ana
[CRO] SENJ

388 - Ćirić Andrijana
[SRB] BEOGRAD

Hoffman Marry - 467
[BRA] BRASIL

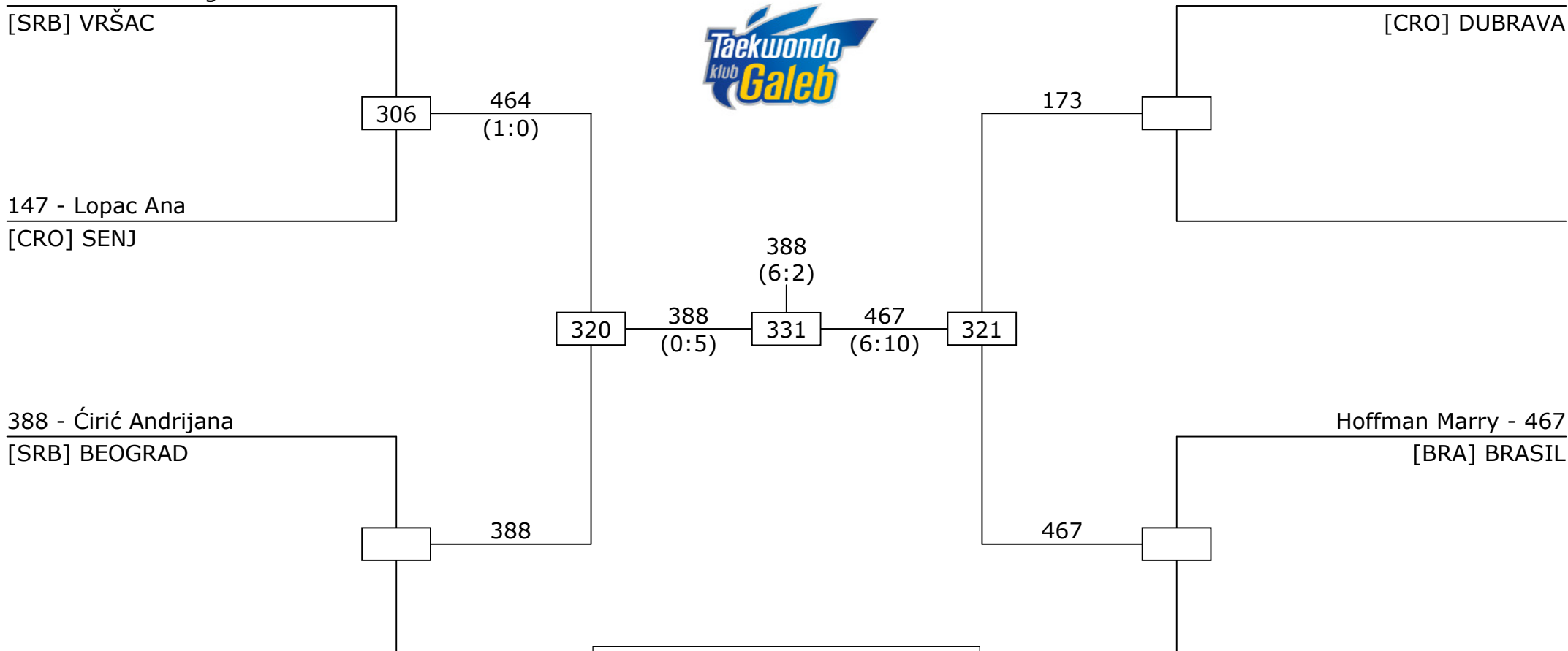

- | |
|------------------------------------|
| 1. Ćirić Andrijana ([SRB] BEOGRAD) |
| 2. Hoffman Marry ([BRA] BRASIL) |
| 3. Jazbec Martina ([CRO] DUBRAVA) |
| 3. Munćan Dragica ([SRB] VRŠAC) |

8th GALEB BELGRADE TROPHY

Competition Area 1

Senior M-54



503 - Matanović Bojan
[MNE] MONTENEGRO STARS

Rakić Bogdan - 510
[SRB] GALEB

050 - Petragonas Nikolaos
[GRE] ATHENS TAEKWONDO TEAM

Kilibarda Miloš - 460
[SRB] OMEGA

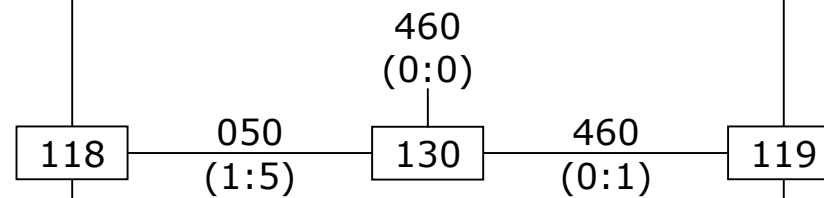

- | |
|--|
| 1. Kilibarda Miloš ([SRB] OMEGA) |
| 2. Petragonas Nikolaos ([GRE] ATHENS TAEKWONDO TEAM) |
| 3. Rakić Bogdan ([SRB] GALEB) |
| 3. Matanović Bojan ([MNE] MONTENEGRO STARS) |

8th GALEB BELGRADE TROPHY

Competition Area 1

Senior M-58



505 - Stevanović Goran
[SRB] TABU

Hukić Ibrahim - 428
[BIH] FOJNICA

427 - Oroz Nikola
[BIH] FOJNICA

Juraj Radanović Ivan - 372
[CRO] ZAPREŠČIĆ

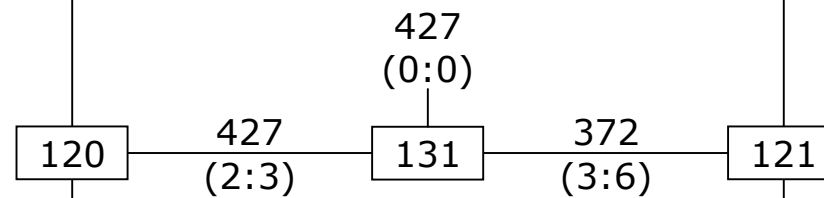

- | |
|---|
| 1. Oroz Nikola ([BIH] FOJNICA) |
| 2. Juraj Radanović Ivan ([CRO] ZAPREŠČIĆ) |
| 3. Hukić Ibrahim ([BIH] FOJNICA) |
| 3. Stevanović Goran ([SRB] TABU) |

8th GALEB BELGRADE TROPHY

Competition Area 2

Senior M-63

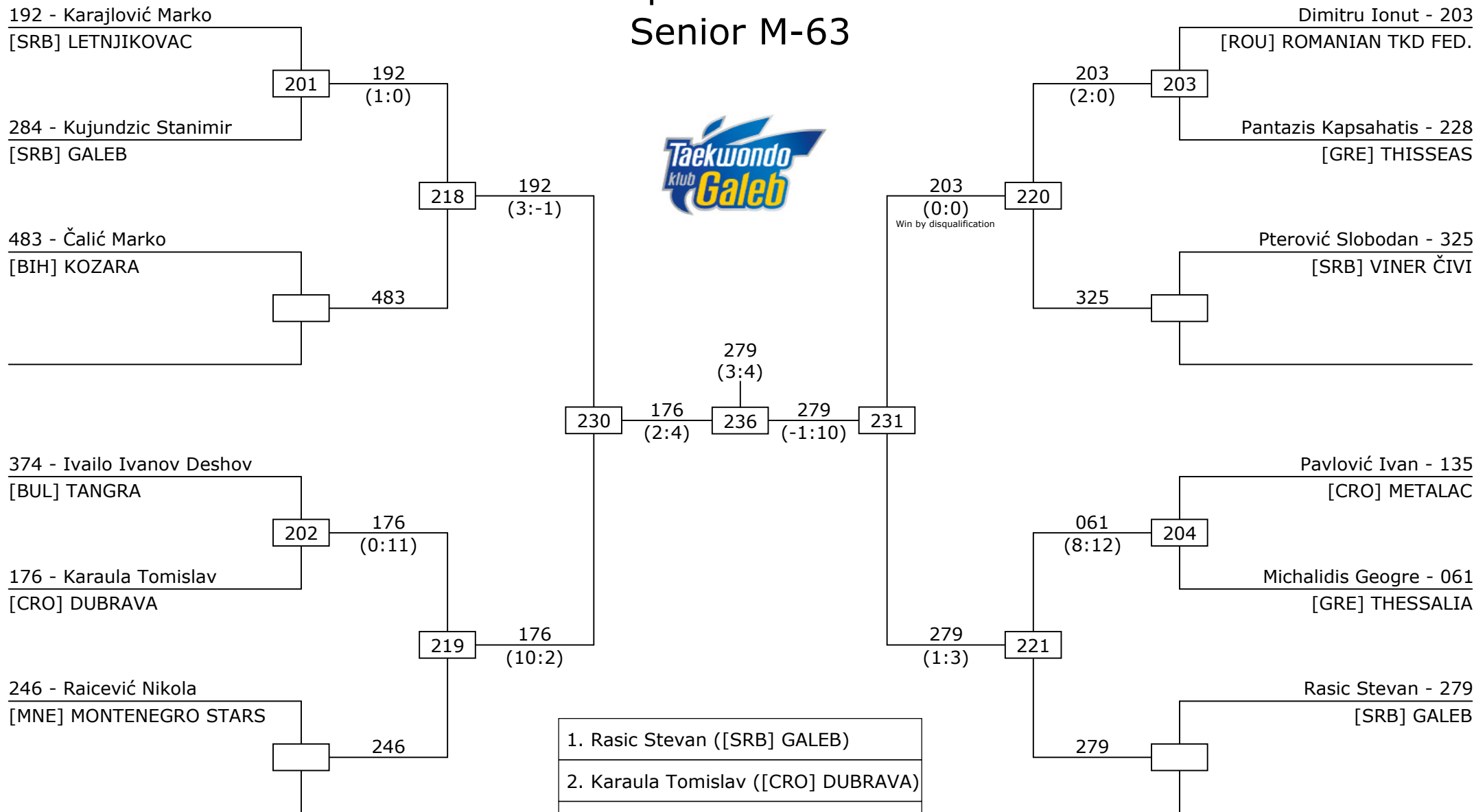

8th GALEB BELGRADE TROPHY

Competition Area 2

Senior M-68

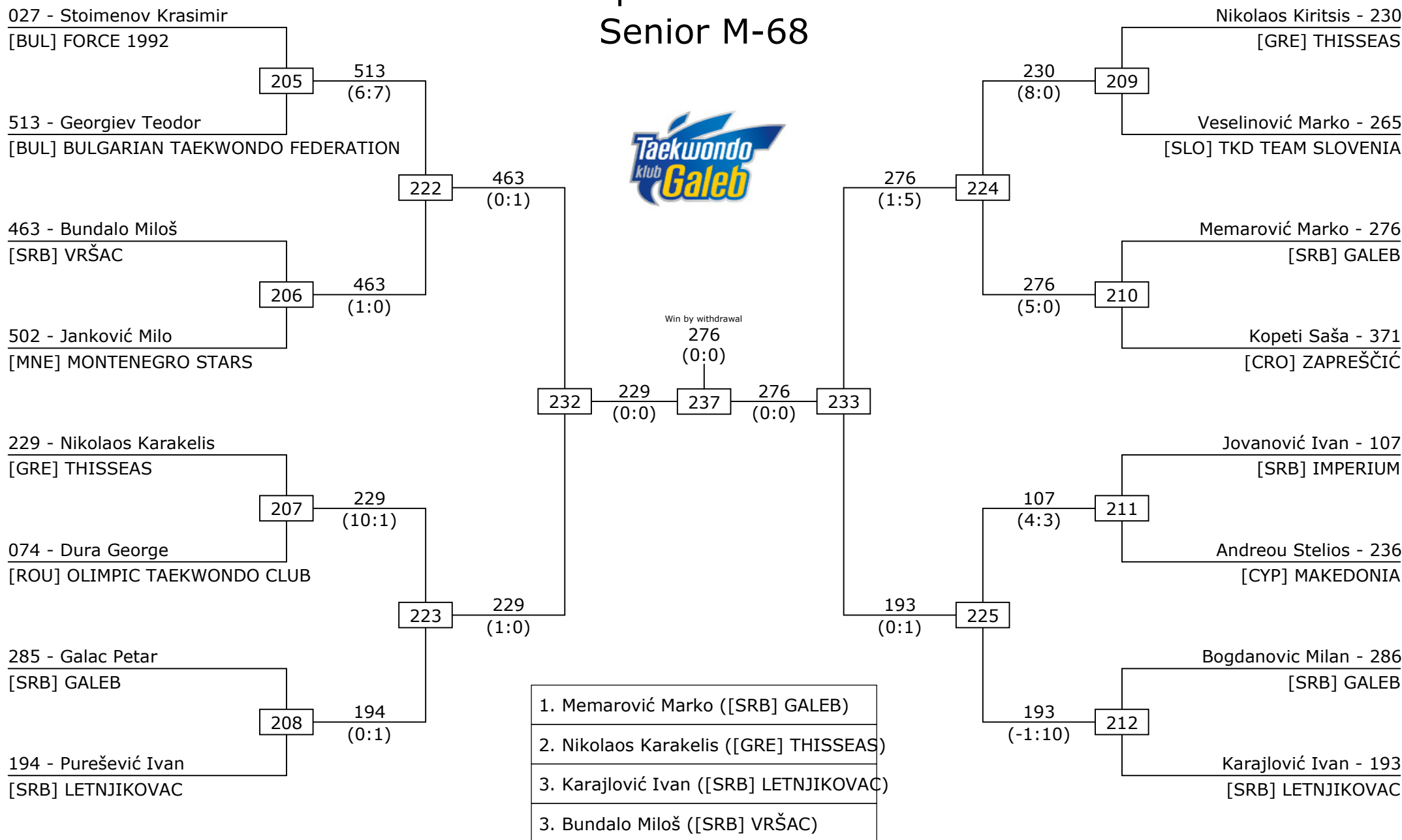

8th GALEB BELGRADE TROPHY

Competition Area 3

Senior M-74

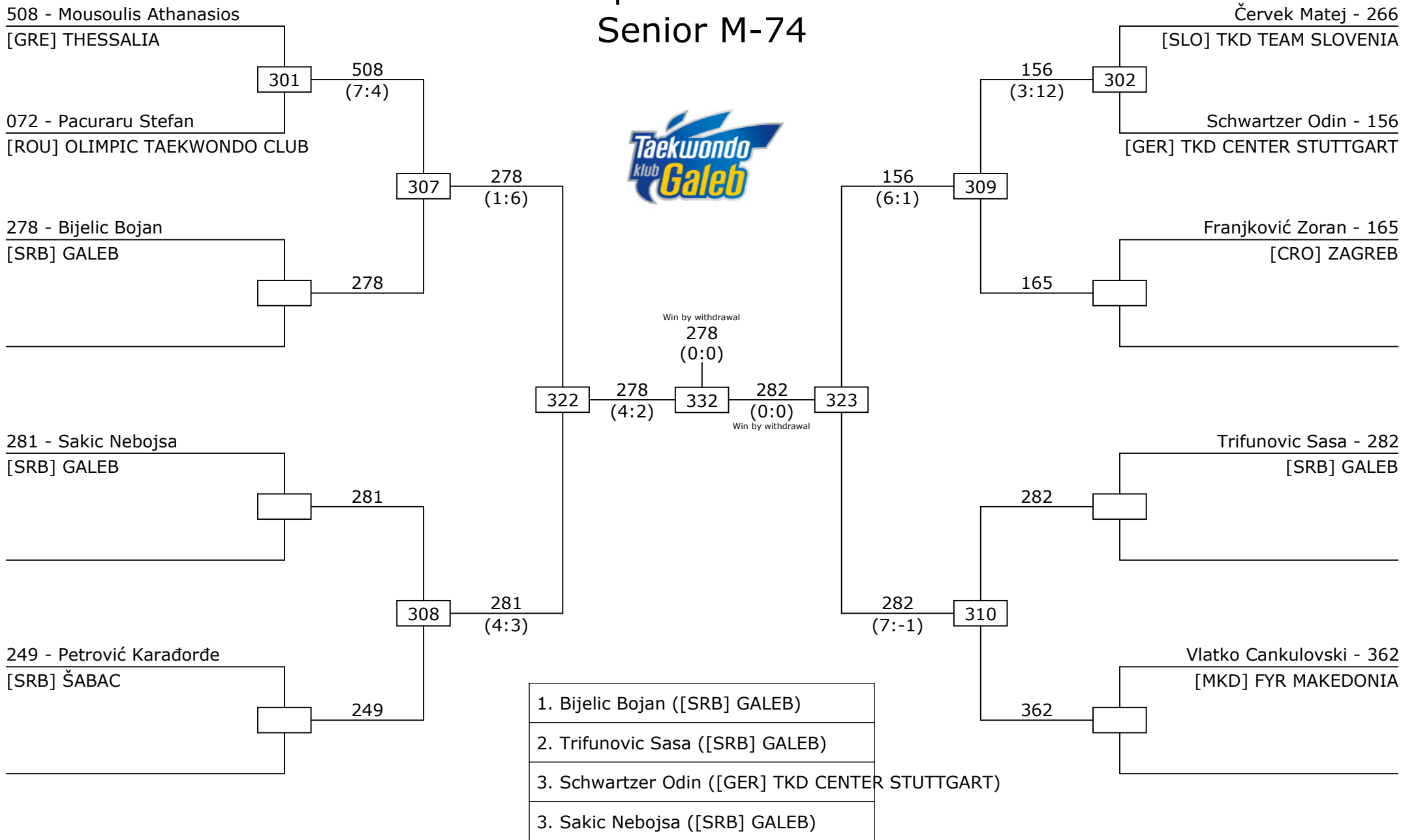

8th GALEB BELGRADE TROPHY

Competition Area 3

Senior M-80

250 - Lazić Miloš
[SRB] ŠABAC

488 - Divović Milan
[SRB] GALEB

268 - Mahnič Jaka
[SLO] TKD TEAM SLOVENIA



Win by Referee Stop Contest (RSC)

Valantič Igor - 267
[SLO] TKD TEAM SLOVENIA

Papagelis Nikolaos - 051
[GRE] ATHENS TAEKWONDO TEAM

Gorus Lukas - 157
[GER] TKD CENTER STUTTGART

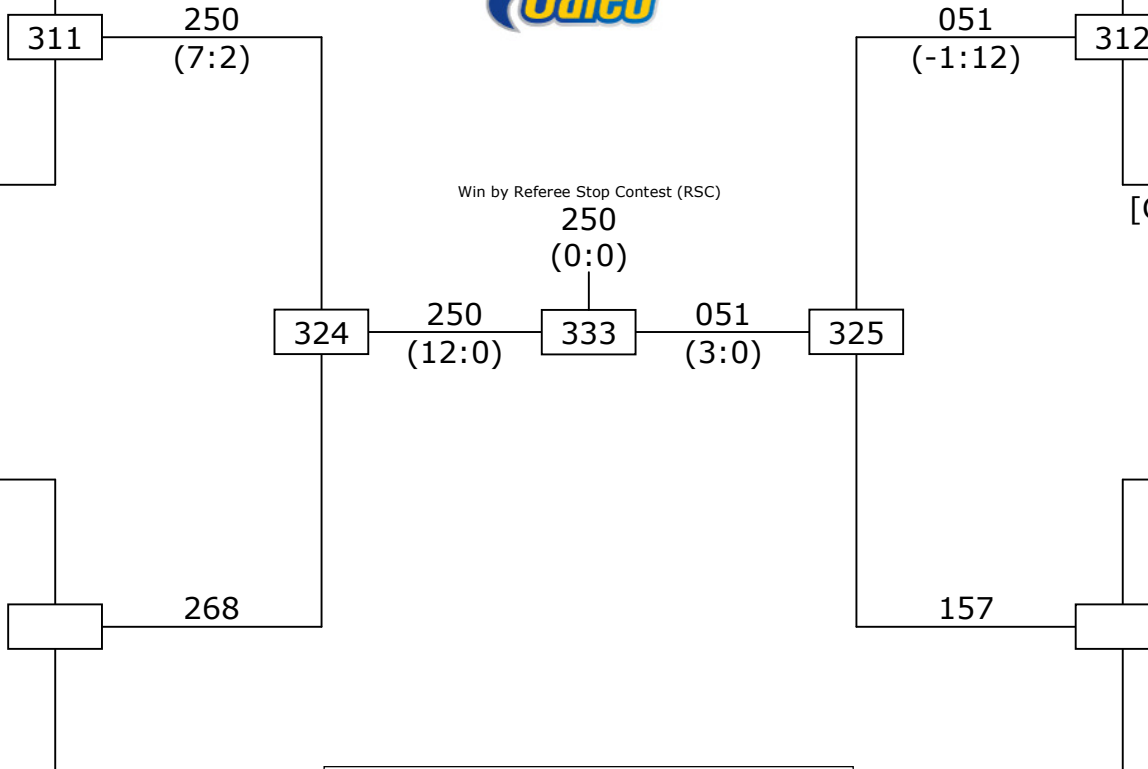

- | |
|---|
| 1. Lazić Miloš ([SRB] ŠABAC) |
| 2. Papagelis Nikolaos ([GRE] ATHENS TAEKWONDO TEAM) |
| 3. Gorus Lukas ([GER] TKD CENTER STUTTGART) |
| 3. Mahnič Jaka ([SLO] TKD TEAM SLOVENIA) |

8th GALEB BELGRADE TROPHY

Competition Area 1

Senior M-87



105 - Živanović Marko
[SRB] BORAC

Tot Balash - 466
[HUN] HUNGARY

062 - Tsolakidis Dimitris
[GRE] THESSALIA

Baby Cristopher - 494
[ROU] ROMANIAN TKD FED.

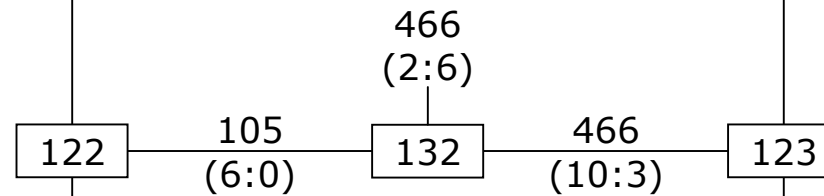

- | |
|--|
| 1. Tot Balash ([HUN] HUNGARY) |
| 2. Živanović Marko ([SRB] BORAC) |
| 3. Baby Cristopher ([ROU] ROMANIAN TKD FED.) |
| 3. Tsolakidis Dimitris ([GRE] THESSALIA) |

8th GALEB BELGRADE TROPHY

Competition Area 1

Senior M+87

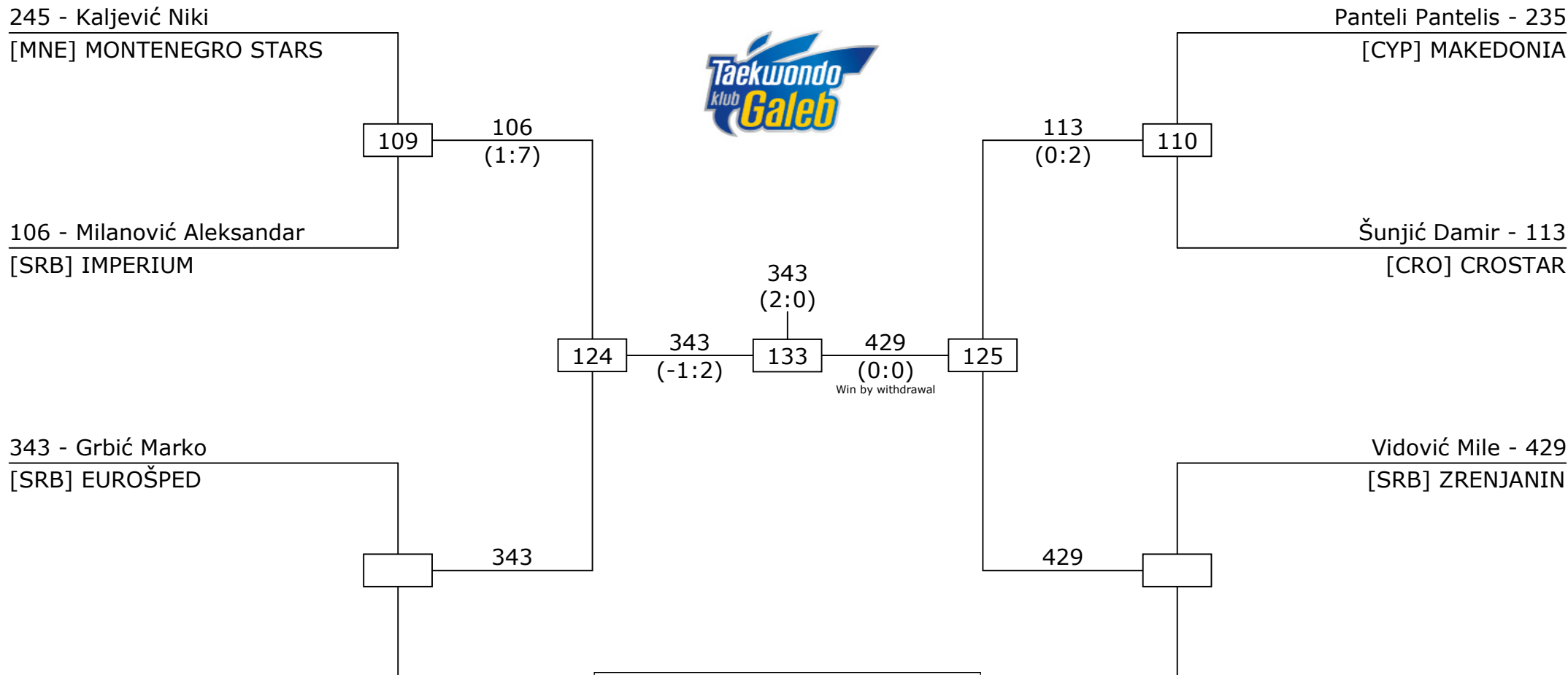

- | |
|--|
| 1. Grbić Marko ([SRB] EUROŠPED) |
| 2. Vidović Mile ([SRB] ZRENJANIN) |
| 3. Šunjić Damir ([CRO] CROSTAR) |
| 3. Milanović Aleksandar ([SRB] IMPERIUM) |