

DEM Junior, Kadett, Master, Para 18

am 15.09.2018

H+87

Draw Sheet

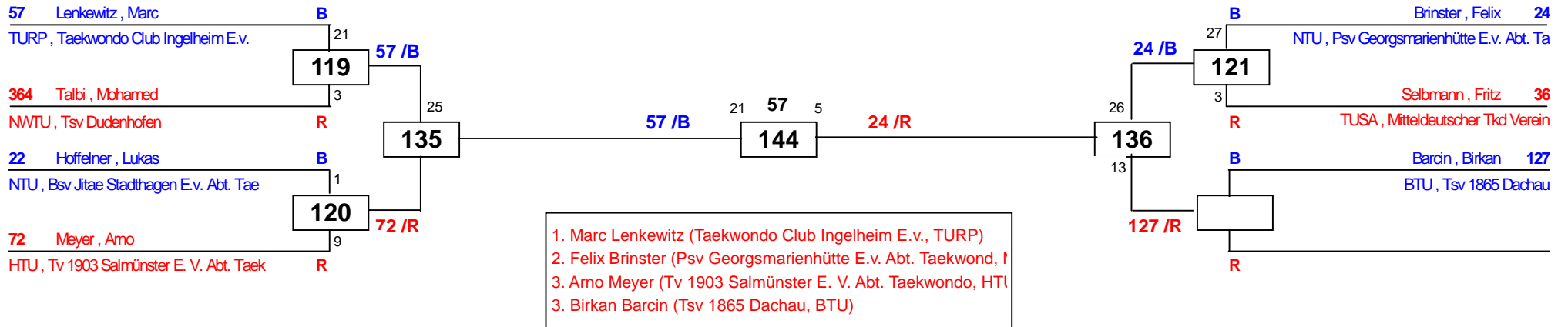

DEM Junior, Kadett, Master, Para 18

am 15.09.2018

H-54

Draw Sheet

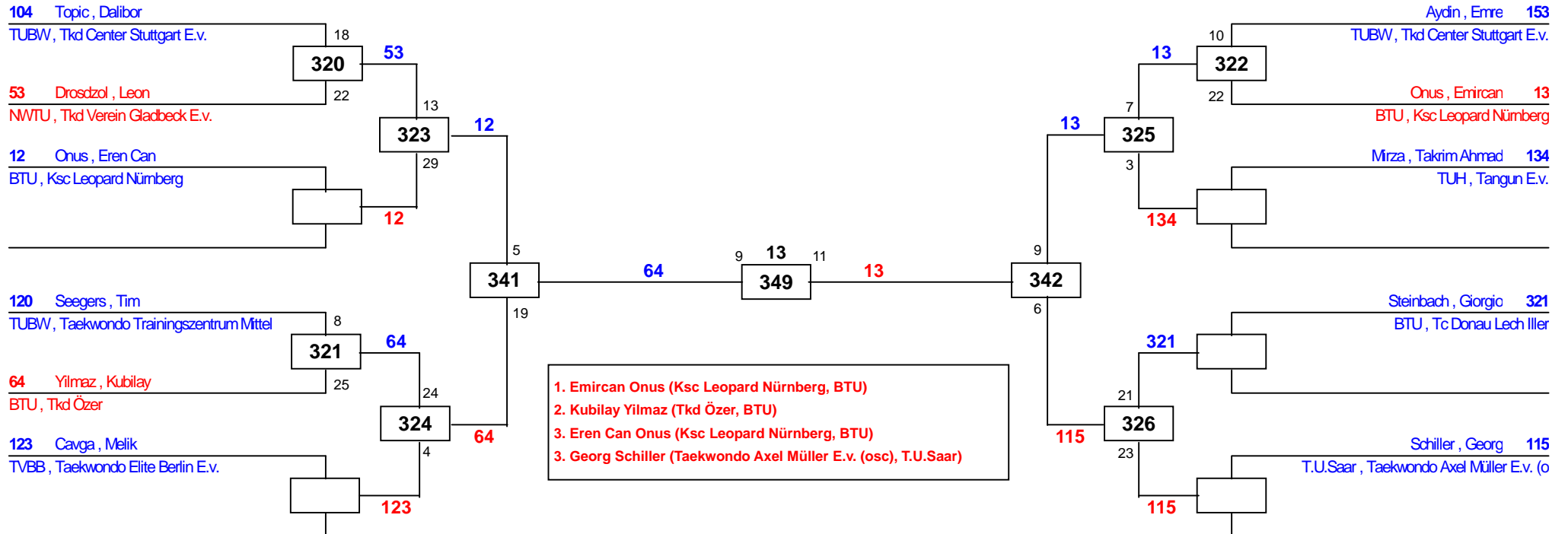

H-58

DEM Junior, Kadett, Master, Para 18

Magdeburg
am 15.09.2018

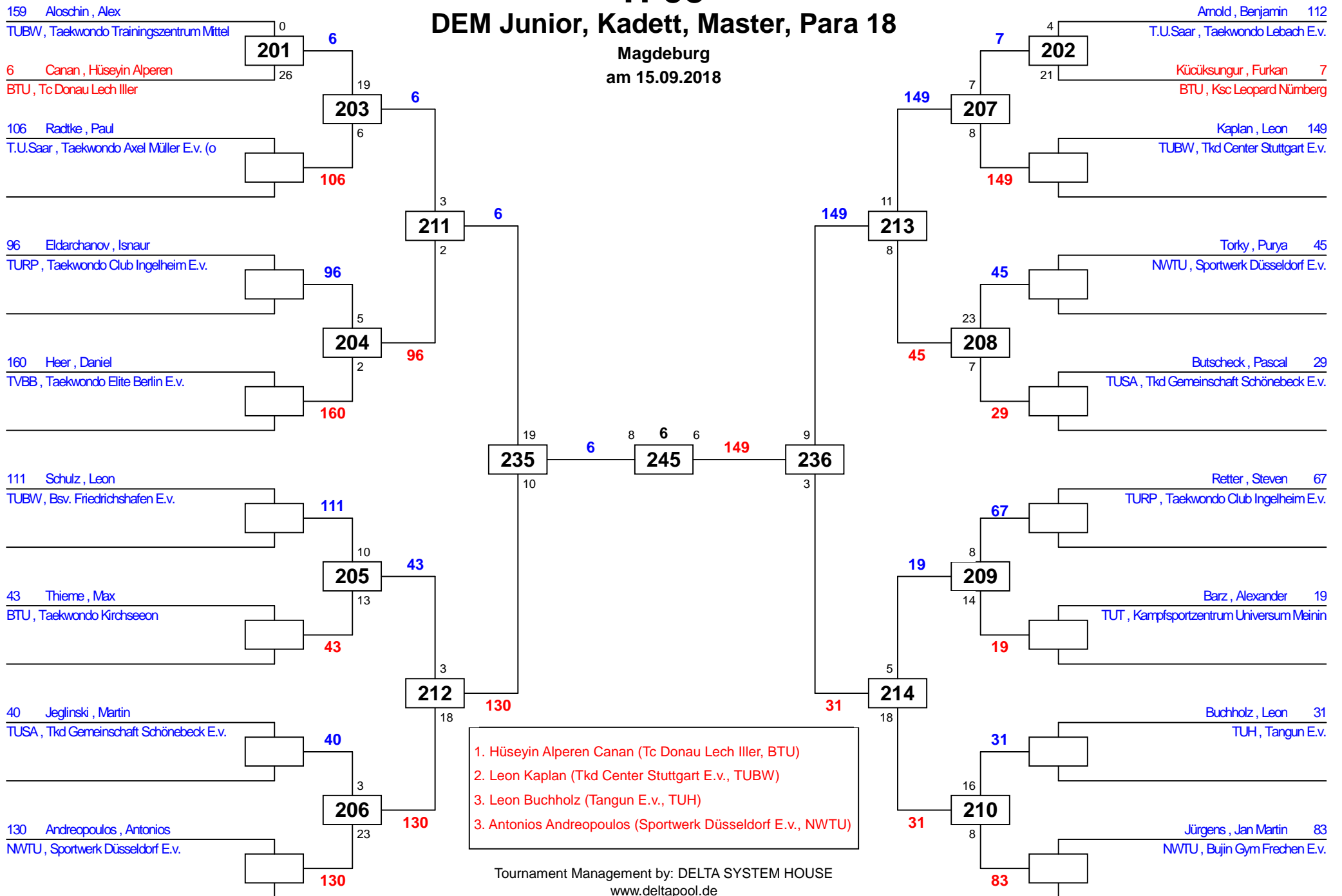

DEM Junior, Kadett, Master, Para 18

am 15.09.2018

H-63

Draw Sheet

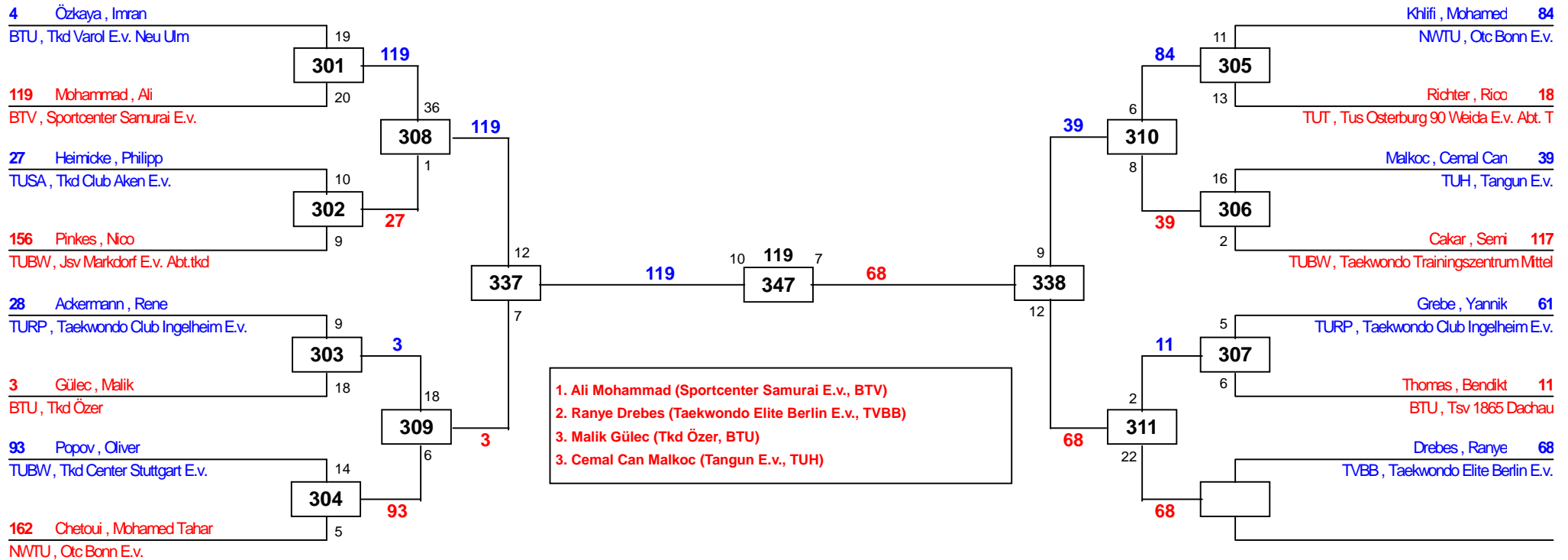

DEM Junior, Kadett, Master, Para 18

am 15.09.2018

H-68

Draw Sheet

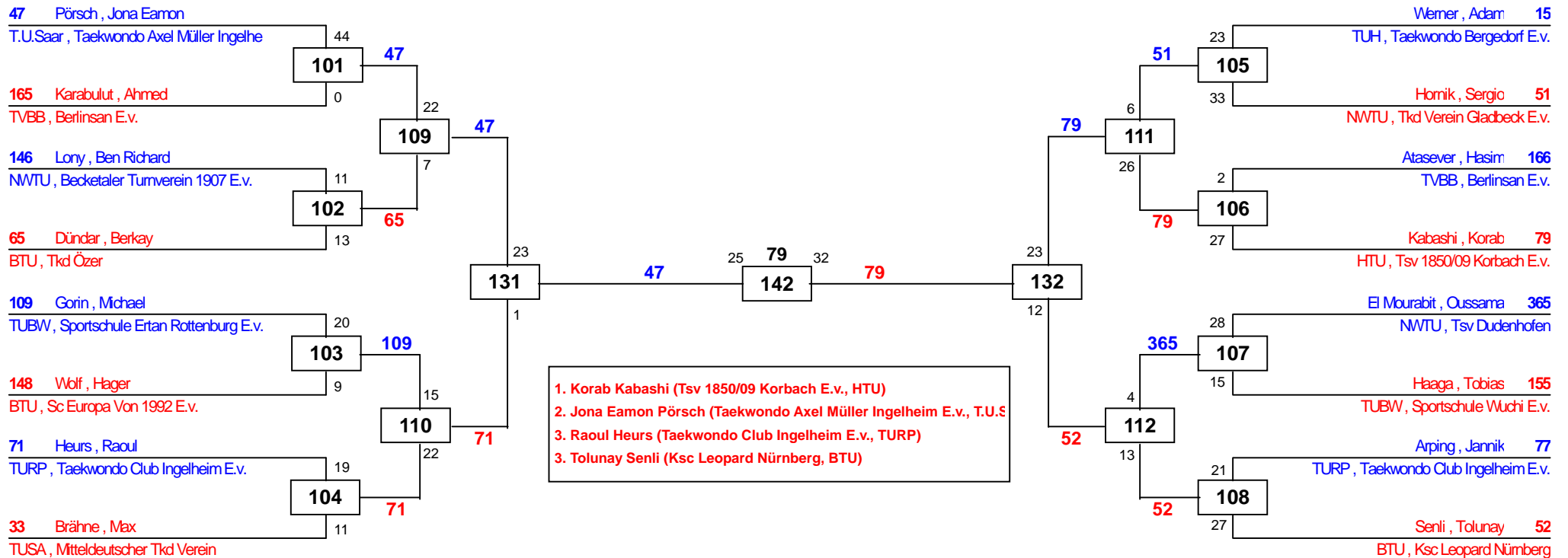

DEM Junior, Kadett, Master, Para 18

am 15.09.2018

H-74

Draw Sheet

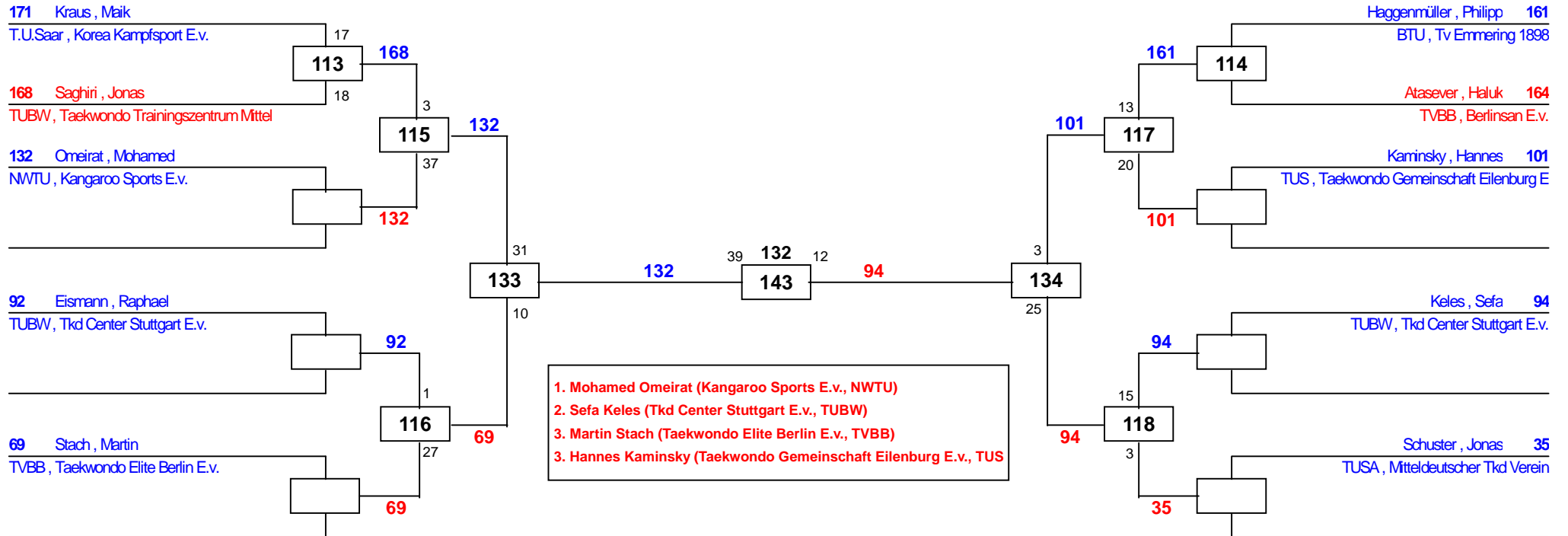

DEM Junior, Kadett, Master, Para 18

am 15.09.2018

H-80

Draw Sheet

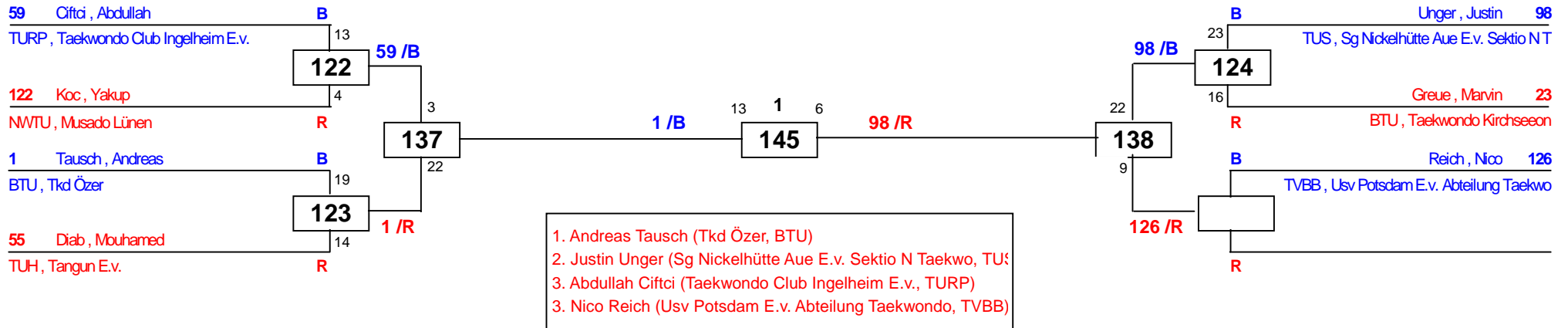

DEM Junior, Kadett, Master, Para 18

am 15.09.2018

H-87

Draw Sheet

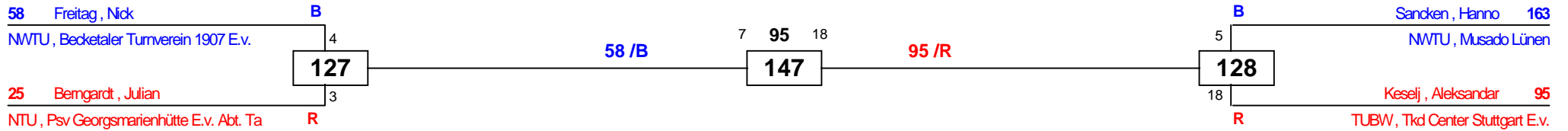

- 1. Aleksandar Keselj (Tkd Center Stuttgart E.v., TUBW)
- 2. Nick Freitag (Becketaler Turnverein 1907 E.v., NWTU)
- 3. Julian Berngardt (Psv Georgsmarienhütte E.v. Abt. Taekwon)
- 3. Hanno Sancken (Musado Lünen, NWTU)

DEM Junior, Kadett, Master, Para 18

am 15.09.2018

D+73

Draw Sheet

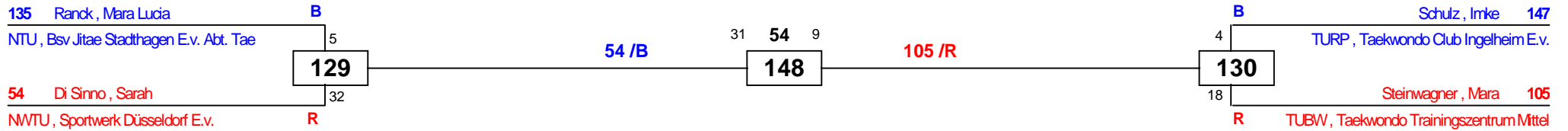

1. Sarah Di Sinno (Sportwerk Düsseldorf E.v., NWTU)
2. Mara Steinwagner (Taekwondo Trainingszentrum Mittelbade)
3. Mara Lucia Ranck (Bsv Jitae Stadthagen E.v. Abt. Taekwondo)
3. Imke Schulz (Taekwondo Club Ingelheim E.v., TURP)

DEM Junior, Kadett, Master, Para 18

am 15.09.2018

D-46

Draw Sheet

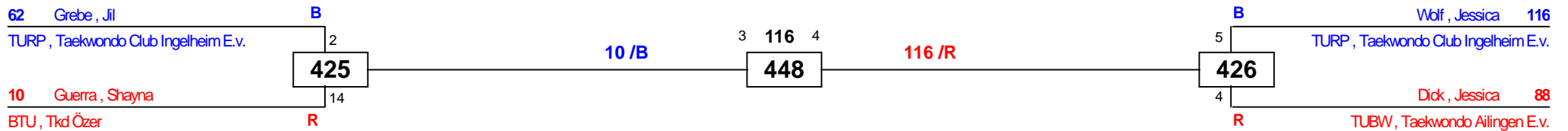

1. Jessica Wolf (Taekwondo Club Ingelheim E.v., TURP)
2. Shayna Guerra (Tkd Özer, BTU)
3. Jil Grebe (Taekwondo Club Ingelheim E.v., TURP)
3. Jessica Dick (Taekwondo Ailingen E.v., TUBW)

DEM Junior, Kadett, Master, Para 18

am 15.09.2018

D-49

Draw Sheet

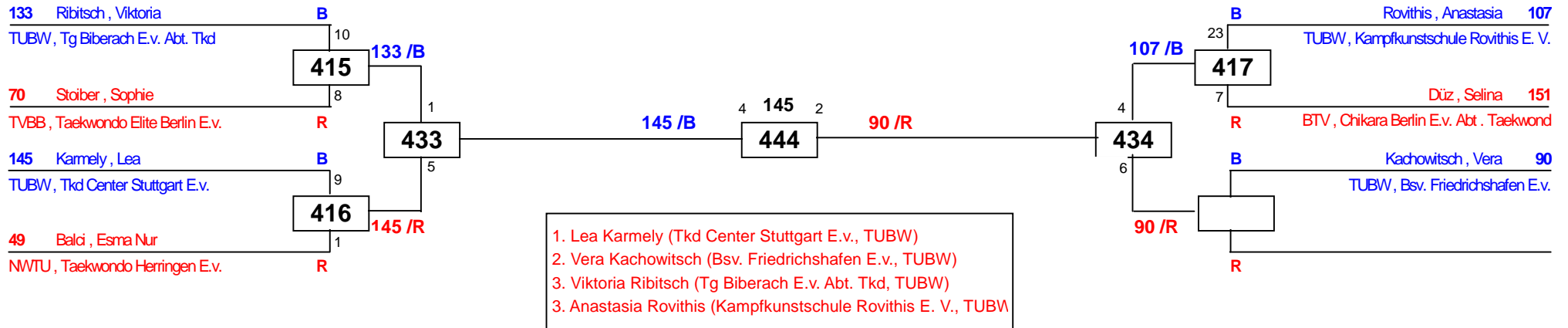

DEM Junior, Kadett, Master, Para 18

am 15.09.2018

D-53

Draw Sheet

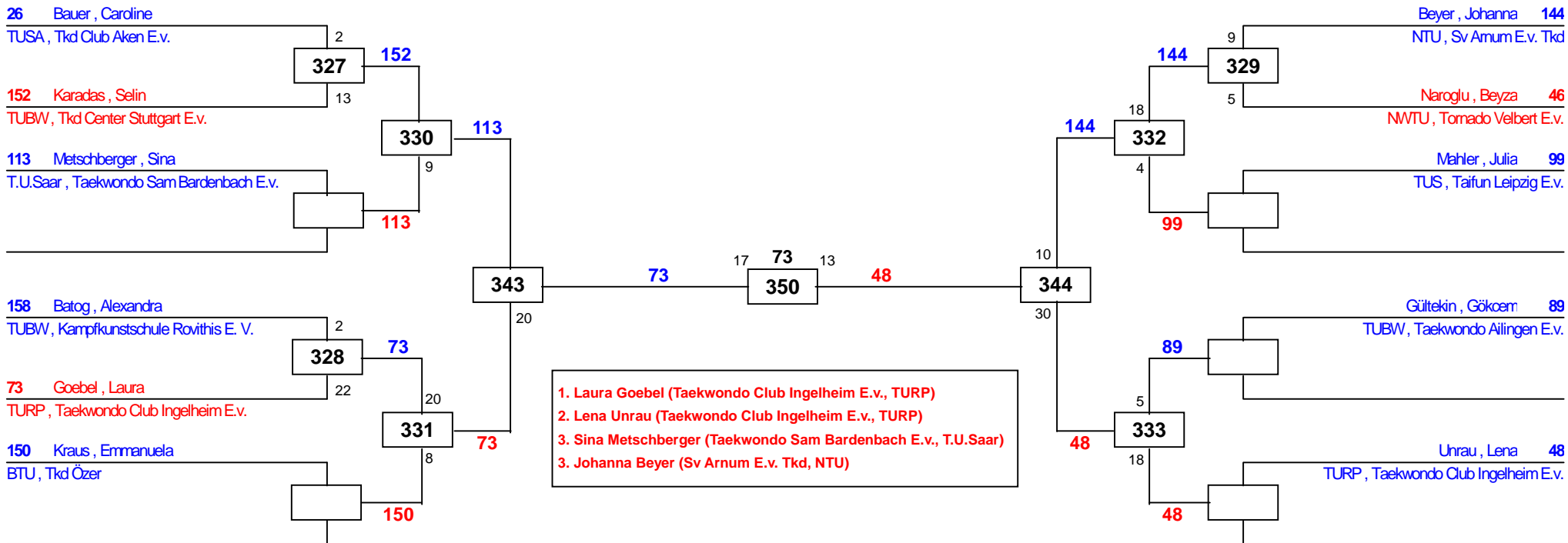

DEM Junior, Kadett, Master, Para 18

am 15.09.2018

D-57

Draw Sheet

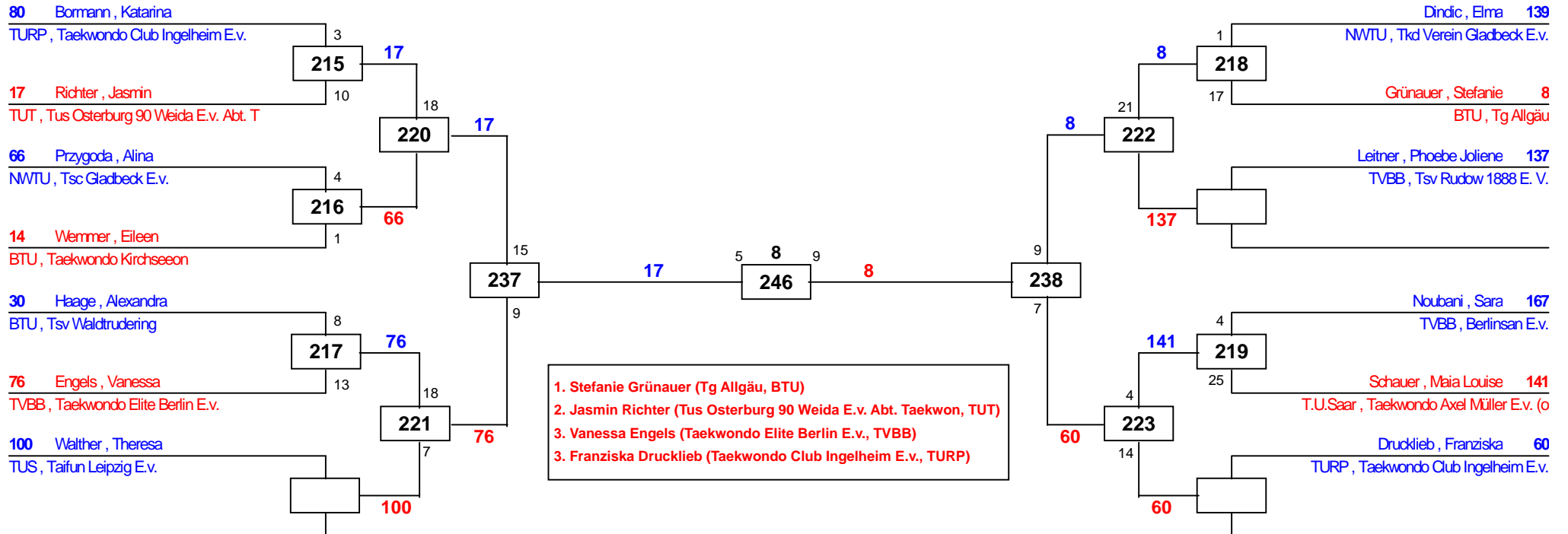

DEM Junior, Kadett, Master, Para 18

am 15.09.2018

D-62

Draw Sheet

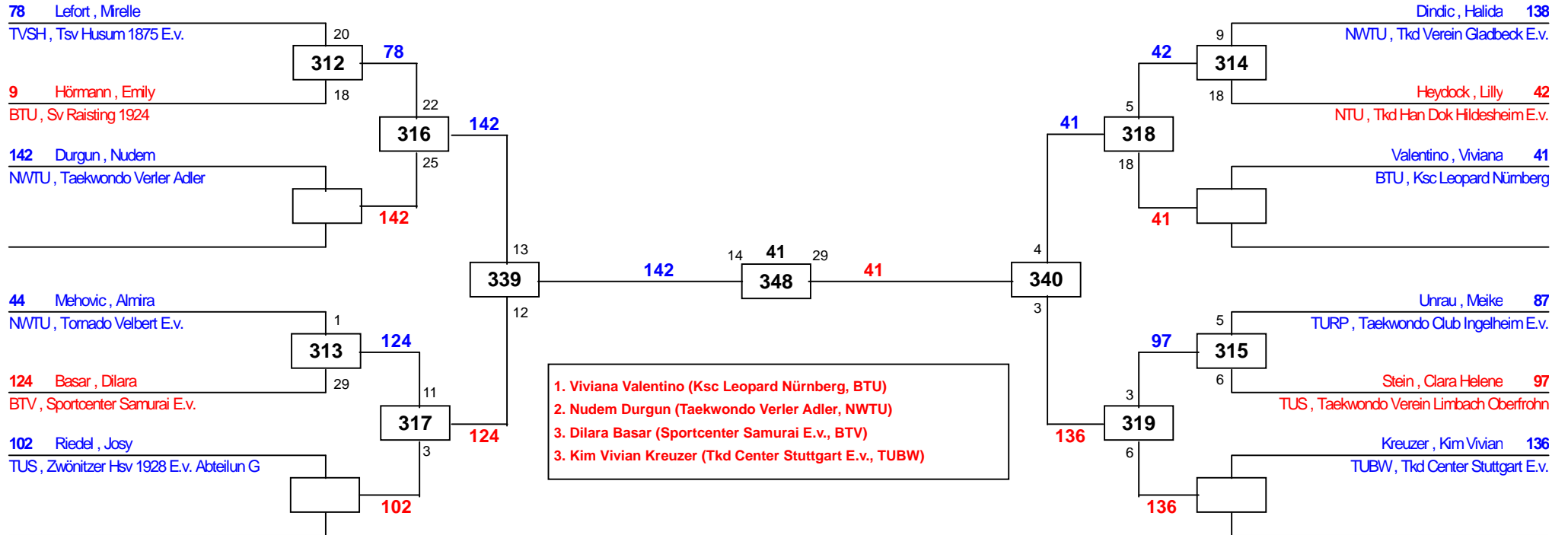

DEM Junior, Kadett, Master, Para 18

am 15.09.2018

D-67

Draw Sheet

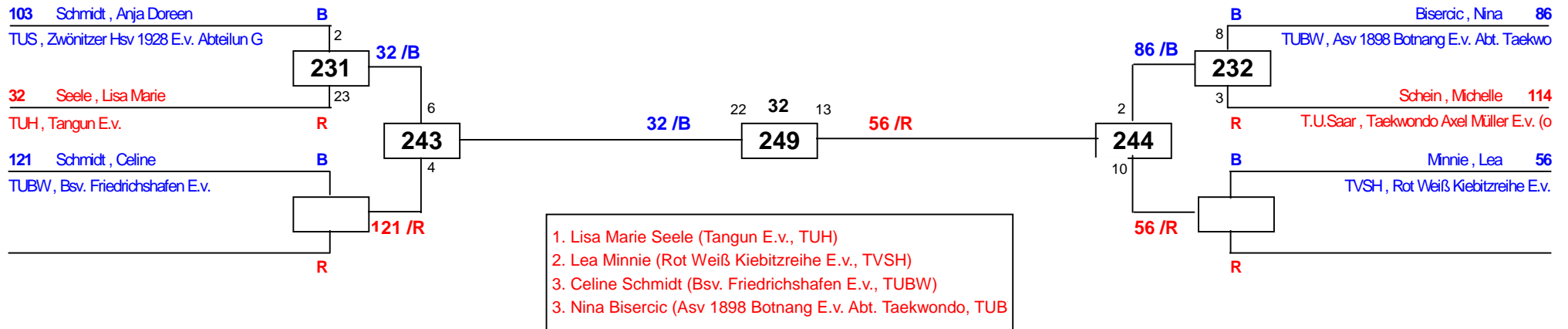

DEM Junior, Kadett, Master, Para 18

am 15.09.2018

D-73

Draw Sheet

